

WHO/BCT/BTS/01.5

Distr.: General

Orig.: English

**HEPATITIS C ASSAYS:  
OPERATIONAL CHARACTERISTICS**  
*(PHASE I)*

**REPORT 2**

**JULY 2001**



**BLOOD SAFETY AND CLINICAL TECHNOLOGY  
WORLD HEALTH ORGANIZATION  
GENEVA**

Copyright © World Health Organization, 2001

This document is issued by WHO for general distribution.

The document is not a formal publication of the World Health Organization (WHO), and all rights are reserved by the Organization. This document may not be reproduced, in part or in whole, without written approval from the contact person listed below. This document must not be used in conjunction with commercial or promotional purposes.

Neither WHO nor the Central Public Health Laboratory, London, UK warrant or represent that the evaluations conducted with the Hepatitis C test kits referred to in this document are accurate, complete and/or error-free. WHO and the Central Public Health Laboratory disclaim all responsibility and liability for any use made of the data contained herein.

The mention of specific companies and of certain manufacturers' products does not imply that they are endorsed or recommended by WHO in preference to others of a similar nature that are not mentioned.

Contact: Dr. G. Vercauteren, Blood Safety and Clinical Technology – WHO – 20, Avenue Appia – 1211 Geneva 27 – Switzerland.

## HEPATITIS C ASSAYS: OPERATIONAL CHARACTERISTICS(PHASE I)

<b>1. Summary</b>	<b>1</b>
<b>2. Background information</b>	<b>2</b>
<b>3. Laboratory aspects of anti-HCV testing</b>	<b>2</b>
3.1 A brief overview	2
3.2 Quality assurance	4
3.3 Safety	4
<b>4. Materials and methods</b>	<b>4</b>
4.1 Assays (test kits) evaluated	4
4.2 Evaluation panels	7
4.2.1 WHO HCV panel	7
4.2.2 Seroconversion panels	8
4.2.3 Performance panels	8
4.3 Laboratory testing	8
4.4 Analysis	9
4.4.1 Sensitivity, specificity confidence limits (CL) and predictive values of anti-HCV tests	9
4.4.2 Inter-reader variability	10
4.4.3 Sensitivity in seroconversion panels	10
4.4.4 Sensitivity in performance panels	11
4.4.5 Additional analyses	11
<b>5. Assay evaluations</b>	<b>11</b>
Group 1: Simple/rapid tests and confirmatory assays	
Table 1: General characteristics and operational aspects	13
Table 2: Comparison of the assays with the confirmatory assays	14
Table 3: Detailed operational aspects	15
Table 4a: Technicians appraisal of the test kit	17
Table 4b: Calculation of ease of performance	18
Table 5: Suitability for use in small laboratories	19
Group 2: ELISAs and reference assays	
Table 6: General characteristics and operational aspects	20
Table 7: Comparison of the assays with the confirmatory assays	21
Table 8: Detailed operational aspects	22
Table 9a: Technicians appraisal of the test kit	24

Table 9b:	Calculation of ease of performance	25
Table 10:	Suitability for use in small laboratories	26
All assays		
Table 11:	Results on seroconversion panels	27
Table 12:	Results on worldwide performance panel	28
Table 13:	Results on low titre performance panel	29
Explanatory notes on Tables 1-13 and Figures 1-2		30
Figure 1:	Relative performance on seroconversion panels	33
Figure 2:	Relative performance on seroconversion, worldwide and low titre panels	34
<b>6.</b>	<b>Annexes</b>	<b>35</b>
Annex 1.	Algorithm for characterization of the WHO anti-HCV panel	35
Annex 2.	Cumulative list of assays evaluated	36
Annex 3.	Cumulative list of assay manufacturers' addresses	39
<b>7.</b>	<b>References</b>	<b>40</b>
<b>8.</b>	<b>Additional reading</b>	<b>40</b>
<b>9.</b>	<b>Acknowledgements</b>	<b>40</b>

## 1. SUMMARY

In 1998, WHO implemented a programme for the evaluation of performance and major operational characteristics of commercially available assays for detection of antibodies to Hepatitis C (HCV). This second report presents the findings of the Phase I evaluations of five anti-HCV assays and the assays used as reference tests. The work was conducted between the 4<sup>th</sup> quarter 2000 and the 1<sup>st</sup> quarter 2001. The anti-HCV assays evaluated and the reference tests included:

### Group 1: Simple/Rapid tests and confirmatory assays: Tables 1-5

- GENEDIA® HCV Rapid (Green Cross Life Science Corp.)
- 4<sup>th</sup> Generation HCV TRI-DOT (J. Mitra & Co. Ltd.)
- INNO-LIA™ HCV Ab III update (Innogenetics)
- CHIRON\* RIBA\* HCV 3.0 SIA (Chiron) (*used as reference test*)

### Group 2: ELISA tests: Tables 6-10

- 3<sup>rd</sup> Generation HCV Microlisa (J. Mitra & Co. Ltd)
- Innostest HCV Ab III (Innogenetics)
- Innostest® HCV Ab IV (Innogenetics)
- Ortho® HCV 3.0/Enhanced SAVe (Ortho-Clinical Diagnostics) (*used as reference test*)
- Monolisa® anti-HCV PLUS (Bio-Rad) (*used as reference test*)

Section 2 of this report provides background information on the evaluations and the intended use of the evaluation results. Sections 3 and 4 present the laboratory aspects of HCV testing and describe the way in which the evaluations were conducted and the results analysed. The results and outcomes of the analysis of the assay evaluations are contained in the tables and figures in section 5. Annex 1, 2 and 3 show respectively, the algorithm for characterization of the WHO HCV panel, the cumulative list of assays evaluated and the addresses of manufacturers of the assays evaluated.

This second report contains Phase I assessments of two simple/rapid tests, 4<sup>th</sup> Generation HCV TRI-DOT and GENEDIA® HCV Rapid, and three enzyme linked immunosorbent assays (ELISA), 3<sup>rd</sup> Generation HCV Microlisa, Innostest HCV Ab III and Innostest® HCV Ab IV. Four reference assays were also included in the report for comparative purposes. Copies of this report are available on request from the Blood Transfusion Safety Team, Department of Blood Safety and Clinical Technology, World Health Organization, 1211 Geneva 27, Switzerland.

## 2. BACKGROUND INFORMATION

In 1998, the World Health Organization (WHO) Blood Safety and Clinical Technology Department, conscious of the need to advise Member States on laboratory aspects associated with Hepatitis B and Hepatitis C testing for blood transfusion safety, initiated a project to provide objective assessments of commercially available assays for detection of Hepatitis B surface antigen (HBsAg) and Hepatitis C (HCV) antibodies, similar to that which has existed for HIV since 1988. This continuing project is coordinated by the Department of Blood Safety and Clinical Technology, WHO; the WHO Collaborating Centre on Transfusion Transmissible Infections, Sexually Transmitted and Blood Borne Virus Laboratory (SBVL), Virus Reference Division, Central Public Health Laboratory, London, UK carries out the laboratory investigations. The aim of the project is to supply those responsible for deciding which tests to use, and potential users of tests, with enough comparative data to apply their own criteria and choose the best tests for their particular situation.

It is intended that the evaluations will be conducted in two phases, the first using a limited panel of well characterized specimens held at the WHO Collaborating Centre (reference laboratory), the second in 3-4 field laboratories. Aliquots of the specimens used in the field evaluations will be sent to the reference laboratory for characterization. The purpose of this 2-phase approach is to expand the number, type and origin of specimens in the evaluation panels and to archive them for use in future evaluations.

The assessments focus on the operational characteristics of these assays, such as ease of performance, sensitivity and specificity on a panel of well-characterized sera of diverse geographical origins, and indicate their suitability for use in small laboratories, i.e. many blood-collection centres in developing countries. In addition, the sensitivity of the assays on seroconversion, low titre and worldwide performance panels is assessed.

The findings of the assessments are published in the form of reports that are intended for use by health policy-makers, directors of blood banks, and managers of national prevention and surveillance programmes. They may be used in conjunction with consideration of other factors, such as experience with a given test, availability, cost, service and trouble-shooting provided locally by manufacturers, to help select assays appropriate to local needs.

## 3. LABORATORY ASPECTS OF ANTI-HCV TESTING

### 3.1 A brief overview

The Hepatitis C virus is the major cause of the disease formerly known as non-A non-B post transfusion hepatitis. Since the introduction in 1990 of anti-HCV screening of blood donations in most industrialized countries, the incidence of this infection in transfusion recipients in this part of the world has been significantly reduced.

HCV, a single stranded RNA virus, is a member of the family *Flaviviridae*. Six major genotypes (1-6) and a series of subtypes of HCV have been identified. Genotypes 1-3 show a worldwide distribution while genotypes 4 and 5 appear predominantly in Africa and genotype 6 in Asia. Following the discovery of HCV and the sequencing of its genome in 1989, the first generation of anti-HCV ELISAs was produced using, as antigens, recombinant proteins complementary to the NS4 region of the HCV genome. These assays showed limited sensitivity and specificity. Second

generation tests, which included recombinant or synthetic antigens from the putative core and non-structural regions NS3 and NS4 resulted in a marked improvement in sensitivity and specificity. The third generation tests include antigens from the NS5 region of the genome, in addition to those used in second generation assays. Third generation tests have improved sensitivity, though this has been shown to be more likely due to the improvements to the core and NS3 antigens rather than the inclusion of the NS5 antigen. However, despite these improvements, the time between infection with HCV and the appearance of detectable antibodies (window period) is generally more than 40 days (Schreiber et al, 1996; Barrera et al, 1995). It is anticipated that test kits will undergo further improvement in the future. The term generation is used to show the development of the kits over time by the manufacturers in their effort to increase the specificity and sensitivity of the assays and each generation does not denote a specific format or configuration of the assay. Some manufacturers use the term generation in their kit title which does not mean a specific format but is indicative of further developments in their assay.

The laboratory diagnosis of HCV infection is usually made on the basis of the detection of circulating antibodies. Serological tests for detecting antibodies to HCV are generally classified as screening tests or confirmatory tests. Screening tests provide the presumptive identification of antibody-positive specimens, whilst confirmatory tests are used to confirm that specimens found reactive with a particular screening test contain antibodies specific to HCV. Several screening tests may be used in a testing algorithm to determine a final sero-status. These second and/or third line tests are generally referred to as supplemental tests.

The most widely used anti-HCV screening tests are ELISAs as they are the most appropriate for screening large numbers of specimens on a daily basis, as is the case in blood transfusion services in industrialized countries. However, many blood transfusion services in resource limited countries process only limited numbers of specimens. Hence, individual tests would be more appropriate. Several simple, instrument and electricity-free screening tests have been developed including agglutination, immunofiltration (flow through) and immunochromatographic (lateral flow) membrane tests. A positive result is indicated by the appearance of a coloured dot or line, or the presence of an agglutination pattern. While most of these tests can be performed in less than 10 minutes, other simple tests are less rapid and their performance requires 30 minutes to 2 hours. The results are read visually. In general, these simple/rapid (S/R) tests are most suitable for use in laboratories that have limited facilities and/or process low numbers of specimens daily.

When a single screening test is used for testing in a population with a very low prevalence of HCV infection, the probability that a person is infected when a reactive test result is obtained (i.e. the positive predictive value) is low, since the majority of people with reactive results are not infected (i.e. the positive results are false). This problem occurs even when a test of excellent quality and having high specificity is used. Accuracy can be improved if additional supplemental or confirmatory test(s), of equal or higher specificity, are used to retest all those samples found reactive by the screening test. Screening and supplemental tests, to be used in an HCV confirmatory strategy, must be selected carefully to ensure that common false reactivity between these assays does not occur. Confirmatory assays that are commercially available for the diagnosis of HCV include line/strip immunoassays and assays using Nucleic Acid Amplification Technologies (NAT).

Line/strip immunoassays have individual recombinant or synthetic antigens applied as separate lines to the solid phase. Therefore the different antigens to which antibodies in a specimen are reacting can be distinguished. The application of established criteria to interpret patterns of reactivity observed permits greater specificity. Examples of such assays include RIBA HCV 3.0 SIA (Chiron Corporation) and Inno-LIA HCV antibody III (Innogenetics).

The interpretation of results from different anti-HCV assays poses difficulties in a significant number of specimens including those collected from individuals suspected of seroconversion. In these cases, qualitative confirmatory NAT assays can provide useful additional information particularly as current commercial versions of these assays are capable of detecting HCV RNA down to 100 copies/ml. On the other hand, NAT assays are technically demanding, require sophisticated laboratory infrastructure and a negative result does not exclude HCV infection. In addition there is some evidence that not all genotypes of HCV are detected equally by NAT assays.

Companies are developing ELISAs for the detection of HCV core antigen. These assays can be used in addition to anti-HCV assays and may provide a valuable tool in the identification of individuals undergoing HCV seroconversion. These assays may be more appropriate as a supplement to anti-HCV antibody tests than using NAT for screening blood donations in countries with limited resources.

### **3.2 Quality assurance**

All laboratories carrying out anti-HCV tests, should have a well-functioning quality assurance programme. It is most important that quality assurance procedures be stringently applied so as to maximize the accuracy of the laboratory results. Procedures for detecting both (technical) laboratory and clerical errors must be included in all protocols. For example, procedures that guarantee the correct identification of initially reactive units of donated blood, which must be discarded, are essential to the maintenance of a safe blood supply. It is recommended that laboratories participate in an external quality assessment at least once a year.

### **3.3 Safety**

The testing of serum or plasma specimens should be performed in such a manner as to minimize occupational risk. Guidelines for good laboratory practice have been developed that, if followed, will ensure safety and keep laboratory accidents to a minimum. For further details see *Biosafety Guidelines for Diagnostic and Research Laboratories Working With HIV*, Geneva, World Health Organization, 1991 (WHO AIDS Series 9) and *Guidelines for the Safe Transport of Infectious Substances and Diagnostic Specimens*, Geneva, World Health Organization, 1997 (WHO/EMC/97.3).

## **4. MATERIALS AND METHODS**

### **4.1 Assays (test kits) evaluated**

Test kits for these assessments were kindly provided to WHO free of charge by each of the manufacturers of the assays under evaluation. The manufacturers were invited to visit the site at which the assessments were to be conducted in order to provide any required training and to ensure that the assays were performed correctly by the laboratory staff carrying out the evaluation of their assays. A brief description of the principle of each of the assays under evaluation, accompanied by a picture showing the appearance of a positive and negative result, is shown below.



**Simple/Rapid tests:****4<sup>th</sup> Generation HCV TRI-DOT (J. Mitra & Co. Ltd.)**

A rapid, visual, sensitive and qualitative in-vitro diagnostic test for the detection of antibodies to Hepatitis C Virus in human serum or plasma. The assay uses an immunofiltration format.

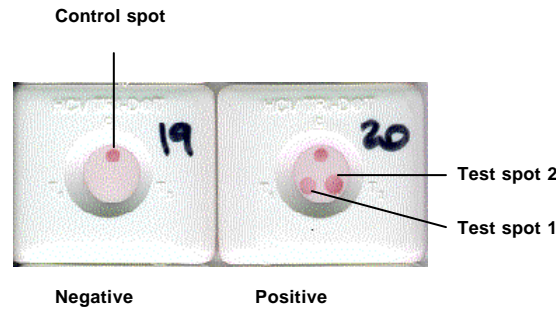
**GENEDIA<sup>®</sup> HCV Rapid (Green Cross Life Science Corp)**

A rapid, qualitative test for the detection of antibodies to hepatitis C virus (HCV) in human serum or plasma, primarily with fresh samples. The assay uses an immunofiltration format.

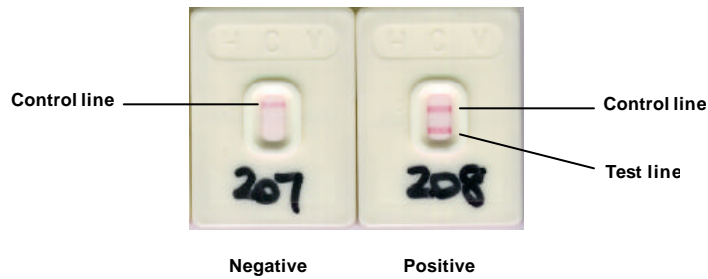

**Confirmatory assays:**

**CHIRON\* RIBA\* HCV 3.0 SIA (Chiron)**

An in vitro qualitative enzyme immunoassay for the detection of antibodies to hepatitis C virus (anti-HCV) in human serum or plasma.

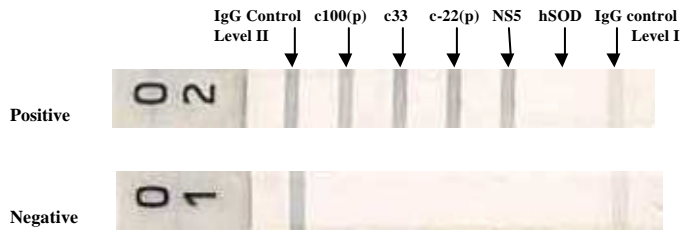

**INNO-LIA™ HCV Ab III update (Innogenetics)**

A line immunoassay for the detection of antibodies to human hepatitis C virus in human serum or plasma.

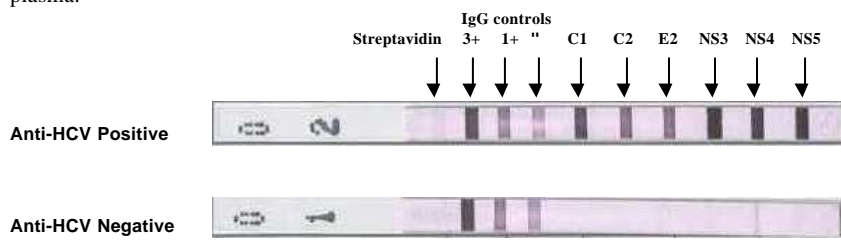

**ELISA tests:**

**3<sup>rd</sup> Generation HCV Microlisa (J. Mitra & Co. Ltd)**

An in vitro qualitative enzyme linked immunosorbent assay for the detection of antibodies against HCV (anti-HCV) in human serum or plasma.

**Innotest HCV Ab III (Innogenetics)**

An enzyme linked immunoassay for the detection of antibodies to human hepatitis C virus (HCV) in human serum or plasma.

**Innotest® HCV Ab IV (Innogenetics)**

An enzyme immunoassay for the detection of antibodies to human hepatitis C virus (HCV) in human serum or plasma

**Ortho HCV 3.0/Enhanced SAvE (Ortho-Clinical Diagnostics)**

A qualitative, enzyme-linked, immunosorbent assay for the detection of antibody to hepatitis C virus (anti-HCV) in human serum or plasma.

**Monolisa anti-HCV PLUS (Bio-Rad)**

An indirect immunoenzymatic technique allowing the detection of the antibodies associated with an infection by Hepatitis C virus in patient serum or plasma.

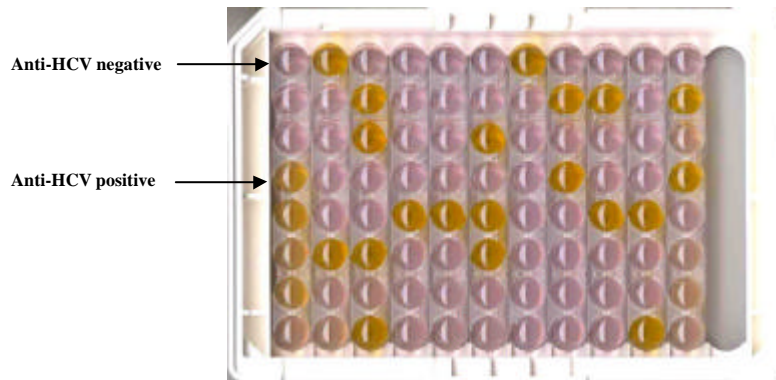

## 4.2 Evaluation panels

### 4.2.1 WHO HCV panel

The phase I evaluations reported here were carried out using a panel of 257 serum specimens (as shown in *Table A*), of which 39 were from Africa, 57 from Asia, 105 from Europe and 56 from South America. The panel contained 68 specimens positive for anti-HCV. All specimens were stored in aliquots at -30°C and were thawed at least once and not more than twice.

**Table A: Composition of WHO anti-HCV Panel: Phase 1**

Origin of specimens	Anti-HCV positive specimens	Anti-HCV negative specimens	Total
Africa	1	38	39
Asia	20	37	57
Europe	40	65	105
Latin America	7	49	56
Total	68	189	257

### Characterization of the WHO HCV Panel

For characterization, specimens in the WHO reference panel were screened by two reference ELISAs, Ortho HCV 3.0 Enhanced SAve (Ortho Clinical Diagnostics) and Monolisa anti-HCV PLUS (Bio-Rad). Specimens negative by both ELISAs were considered anti-HCV negative. Specimens showing reactivity with either or both ELISAs were further characterized using the CHIRON\* RIBA\* HCV 3.0 (Chiron).

When results of the reference ELISAs and the CHIRON\* RIBA\* HCV 3.0 were all positive, a specimen was considered anti-HCV positive. When the initial ELISA results were discordant, specimens having negative CHIRON\* RIBA\* HCV 3.0 results were considered anti-HCV negative. Similarly, specimens showing discordant ELISA reactivity and a positive CHIRON\* RIBA\* HCV 3.0 were considered anti-HCV positive. Specimens with discordant ELISA results and indeterminate CHIRON\* RIBA\* HCV 3.0 were excluded from the panel. No such specimens were found, however.

This algorithm, used for determination of the anti-HCV status of specimens in the WHO HCV reference panel, is shown diagrammatically in Annex 1.

The results of the reference assays were interpreted according to the manufacturers' instructions.

#### 4.2.2 Seroconversion panels

The seroconversion panels used in this evaluation were series of specimens, sequentially collected over a period of time, from individuals developing antibodies due to a primary infection. Four commercial seroconversion panels, PHV907, PHV908, PHV911 and PHV913 [Boston Biomedica Inc.(BBI)], were tested on each of the 5 assays evaluated and the four reference assays. These panels consisted of a total of 29 specimens collected from 4 individuals during seroconversion.

#### 4.2.3 Performance panels

Additionally, one anti-HCV worldwide performance panel, WWHV301 (BBI), containing 20 members of varying HCV subtypes and one anti-HCV low titre performance panel, PHV104 (BBI), containing 15 members that had been included because of their low reactivity in ELISA assays, were tested.

### 4.3 Laboratory testing

All testing was performed according to the manufacturer's instructions. The specimens in the WHO HCV panel were randomized before testing and all assay runs were performed by one operator. Visual interpretations of the results of the simple/rapid test assays under evaluation were made independently by three technicians. When the three technicians interpreted the results differently

from each other, the consensus was recorded as that interpretation which occurred 2 out of 3 times. In cases where all three interpretations were different, the result was recorded as indeterminate.

Specimens in the WHO HCV panel that gave initial results discordant from the reference results, were retested in duplicate. Any result that occurred twice out of the three tests was recorded as the final result. Samples from commercial panels giving discordant results were not repeated.

#### 4.4 Analysis

##### 4.4.1 Sensitivity, specificity confidence limits (CL) and predictive values of anti-HCV tests

The formula for calculation of sensitivity, specificity and predictive values is represented diagrammatically in Table B.

**Table B: Calculation of sensitivity, specificity and predictive values**

		True anti-HCV status		
		+	-	
Results of assay under evaluation	+	<b>a</b> True-positives	b False-positives	a+b
	-	c False-negatives	<b>d</b> True-negatives	c+d
		a+c	b+d	

$$\begin{aligned} \text{Sensitivity} &= a/(a+c) & \text{Positive predictive value} &= a/(a+b) \\ \text{Specificity} &= d/(b+d) & \text{Negative predictive value} &= d/(c+d) \end{aligned}$$

**Sensitivity:** Is the ability of the assay under evaluation to identify correctly sera that contain antibody to HCV (reference assays positive). Thus, sensitivity is the number of true positive sera recognized by the assay under evaluation as positive (a), divided by the number of sera identified by the reference assays as positive (a+c), expressed as a percentage.

**Specificity:** Is a measure of the ability of the assay under evaluation to identify correctly sera that do not contain antibody to HCV (reference assays negative). Thus, specificity is the number of true negative sera recognized by the assay under evaluation as negative (d), divided by the number of sera identified by the reference assays as negative (b+d), expressed as a percentage.

NOTE: Samples that gave indeterminate results with the assays under evaluation were included in the analyses as a false result.

**Confidence limits (CL):** The 95% confidence limits are a means of determining whether observed differences in sensitivity or specificity between assays are significant or not. Exact 95% confidence limits for binomial proportions were calculated from the F-distribution (Armitage P. and Berry G. Statistical Methods in Medical Research, 2<sup>nd</sup> Edition. Blackwell Scientific Publications, Oxford, 1987, page 119).

**Predictive Values:**

The **positive predictive value (PPV)** is the probability that when the test is reactive, the specimen does contain antibody to HCV. This may be calculated in two ways:

1. using the simple formula  $a/(a+b)$  which will give an approximate value (see Table B).
2. using the more precise formula which takes the prevalence of HCV in the population into account

$$\text{PPV} = \frac{(\text{prevalence})(\text{sensitivity})}{(\text{prevalence})(\text{sensitivity}) + (1 - \text{prevalence})(1 - \text{specificity})}$$

The **negative predictive value (NPV)** is the probability that when the test is negative, a specimen does not have antibody to HCV. This may be calculated using:

1. the simple formula  $d/(c+d)$  which will give an approximate value (see Table B).
2. the more precise formula which takes the prevalence of HCV in the population into account:

$$\text{NPV} = \frac{(1 - \text{prevalence})(\text{specificity})}{(1 - \text{prevalence})(\text{specificity}) + (\text{prevalence})(1 - \text{sensitivity})}$$

The probability that a test will accurately determine the true infection status of a person being tested varies with the prevalence of HCV infection in the population from which the person comes. In general, the higher the prevalence of HCV infection in the population, the greater the probability that a person testing positive is truly infected (i.e. the greater the PPV). Thus, with increasing prevalence, the proportion of serum samples that are false-positive decreases; conversely, the likelihood that a person showing negative test results is truly uninfected (i.e. the NPV), decreases as prevalence increases. Therefore, as prevalence increases, so does the proportion of samples testing false-negative.

For calculating the positive and negative predictive values recorded in this report, the more precise formula at option 2 was used.

**4.4.2 Inter-reader variability**

The inter-reader variability was calculated as the percentage of specimens for which initial test results were differently interpreted (i.e. positive, negative or indeterminate) by the independent readers.

**4.4.3 Sensitivity in seroconversion panels**

The results obtained from seroconversion panels using the assays under evaluation were compared with those obtained using Ortho HCV 3.0/Enhanced SAve, the assay arbitrarily designated the reference for determination of relative sensitivity in these panels. For each seroconversion series (panel) the first specimen in the sample sequence to become reactive with Ortho HCV

3.0/Enhanced SAvE was assigned the value “0”. Results from the assays under evaluation were compared with Ortho HCV 3.0/Enhanced SAvE by determining the difference between the specimen assigned value “0” and the relative position in the sample sequence of the first specimen which showed a reactive result with each of the assays under evaluation. For example, if an assay became reactive two specimens earlier in a series than Ortho HCV 3.0/Enhanced SAvE, the value assigned for that series in that assay was -2. Similarly, if an assay became reactive one specimen later than Ortho HCV 3.0/Enhanced SAvE, the value assigned was +1. The assigned values over the 4 seroconversion series were averaged to determine a mean relative seroconversion sensitivity index for each assay and the 95% confidence limits were determined.

#### **4.4.4 Sensitivity in performance panels**

The number of samples correctly identified in the worldwide and low titre performance panels was determined by comparison with the anti-HCV status assigned (expected results) following interpretation of the combined reference tests, the Ortho HCV 3.0/Enhanced SAvE and CHIRON\* RIBA\* HCV 3.0. The CHIRON\* RIBA\* HCV 3.0 data were provided by BBI.

#### **4.4.5 Additional analyses**

The technical aspects of the assays under evaluation were assessed by the technician who performed the testing. These assessments, along with other selected assay characteristics, contributed to an overall appraisal of each assay’s suitability for use in small laboratories. To enable comparison between assays, an arbitrary scoring system was used to rate specified assay characteristics.

## **5. ASSAY EVALUATIONS**

The results from the 5 test kits evaluated have been divided into 2 groups. Results from the Group 1 assays (2 test kits and 2 reference assays) are presented in tables 1-5 and 11-13, and results from the Group 2 assays (3 test kits and 2 reference assays) are presented in tables 6-13. Tables 1 and 6 summarize the general characteristics of the assays. Results of the assays evaluated as compared to the reference tests are given in Tables 2 and 7; Tables 3 and 8 provide further details of operational aspects. Factors taken into account in the calculation of ease of performance and suitability for use in small laboratories are listed in Tables 4a, 4b and Table 5 for the Group 1 kits and in Tables 9a, 9b and Table 10 for the Group 2 kits. Performance of the assays under evaluation on early seroconversion panels, a world-wide performance panel and a low titre panel is given in Tables 11-13. The relative performance of all 5 of the assays under evaluation, compared to the reference tests in seroconversion panels, is shown in Figure 1, while Figure 2 represents the comparison in performance in both commercial performance panels. Explanatory notes are provided at the end of the assay evaluation tables.

## **ASSAY EVALUATIONS**



**Group 1: Simple/rapid and confirmatory assays**

**Table 1. General characteristics and operational aspects**

NAME	GENEDIA® HCV Rapid	4 <sup>th</sup> Generation HCV TRI-DOT	RIBA HCV 3.0	InnoLIA HCV Ab III Update
Company	Green Cross Life Science Corp, Seoul, Korea	J. Mitra & Co. Ltd., New Delhi, India	Chiron Corporation Emeryville, USA	Innogenetics, Ghent, Belgium
Assay type	immunofiltration	immunofiltration	Strip immunoblot	Strip immunoblot
Antigen type	recombinant	recombinant proteins and synthetic peptides	encoded antigens/peptides	recombinant proteins and synthetic peptides
Solid phase	membrane	membrane	membrane	membrane
Specimen type	serum/plasma	serum	serum/plasma	serum/plasma
Number of tests per kit (product code)	20 (F3201) 100 (F3202)	10 (HC030010) 50 (HC030050) 100 (HC030100)	30 (930780)	20 (K-1085)
Lot numbers evaluated (expiry date)	3320026 (Feb. '01)	HCD14120 (Nov. '01) HCD15120 (Nov. '01)	NA5178 (Nov. '99)	1085059A (May '00)
Shelf life at ( °C)	6 months (2 - 30)	12 months (4 - 8)	not available	not available
Volume of serum needed (µ) Final dilution of serum	40 none	50 none	20 1/51	10 1/101
Total time to perform the assay: h. min. (number of sera)	0.02 (1)	0.05 (1)	7.45 (28 + 2 controls)	18.45 (18 + 2 controls)
Reading	visual	visual	visual	visual
Price/test US\$	2.00 (20 test kit)	2.00 (10 test kit) 1.90 (50 test kit) 1.80 (100 test kit)	35.00	not available

**Table 2. Comparison of the assays with reference tests**

NAME	GENEDIA® HCV Rapid	4 <sup>th</sup> Generation HCV TRI-DOT	RIBA HCV 3.0	InnoLIA HCV Ab III Update
Final Sensitivity % (95 CL)* n = 68	98.5 (92.1 – 100.0)	100.0 (94.7 – 100.0)	100 (94.7 – 100.0)	100 (94.7 – 100.0)
Initial Specificity % (95 CL)*	97.4 (93.9 – 99.1)	98.9 (96.2 – 99.9)	not tested	not tested
Final Specificity % (95 CL)* n = 189	98.4 (95.4 – 99.7)	98.9 (96.2 – 99.9)		
Indeterminate results %	1.6	0	0	0
Initial inter-reader variability %	5.1	0.4	not applicable	not applicable
PPV 0.1%	38.3	47.9	not applicable	not applicable
5.0%	96.4	82.7		
10.0%	87.2	91.0		
NPV 0.1%	100.0	100.0	not applicable	not applicable
5.0%	99.9	100.0		
10.0%	99.8	100.0		

\* 95 % Confidence Limits

**Table 3. Detailed operational aspects**

NAME	GENEDIA® HCV Rapid	4 <sup>th</sup> Generation HCV TRI-DOT	RIBA HCV 3.0	InnoLIA HCV Ab III Update
Dimension (cm) of kit: w-l-h	19.0 – 28.0 – 11.0 (20 tests)	10.0 – 10.5 – 6.5 (10 tests) 13.5 – 16.0 – 10.0 (50 tests) 15.0 – 24.5 – 9.5 (100 tests)	20.0 -23.0 –11.0	16.5 –19.0 –14.0
Storage conditions (°C)	2 – 30	4 - 8	2 – 8	2 – 8
Incubation temperature (°C)	room temperature	20 - 25	15-30 room temperature	15-30 room temperature
Reading endpoint stability (h.min)	0.10	none, results must be read immediately	3.0	indefinitely if stored in dark
Stability after dilution/ reconstitution/ opening at (°C)				
- antigen	expiry date (2 – 30)	expiry date (4 - 8)	expiry date (2 – 8)	expiry date (2 – 8)
- controls	not applicable	not applicable	expiry date (2 – 8)	expiry date (2 – 8)
- sample diluent	not applicable	not applicable	expiry date (2 – 8)	expiry date (2 – 8)
- conjugate	not applicable	not applicable	expiry date (2 – 8)	18 hours (15 – 30)
- substrate	not applicable	not applicable	1 hour (15 – 30)	18 hours (15 – 30)
- wash buffer	not applicable	not applicable	1 week (15 – 30)	2 weeks (2 – 8)
Number of sera per run minimum – maximum	1 – 18	1 – 3-4	1 – 28	1 – 18
Number of controls per test run	2	upon request	2	2
- negative	1	0	1	1
- cut-off/weak positive	0	0	0	0
- positive	1	0	1	1
- blank	0	0	0	0
internal control : reagent control	yes	yes	no	yes
: sample addition control	yes	yes	yes	yes

**Table 3. (continued) Detailed operational aspects**

NAME	GENEDIA® HCV Rapid	4 <sup>th</sup> Generation HCV TRI-DOT	RIBA HCV 3.0	InnoLIA HCV Ab III Update
Estimated time to perform one run: h. min (number of sera)	0.02 (1)	0.05 (1)	6.30 (1 + 2 controls)	18.0 (1 + 2 controls)
Equipment needed but not provided in the kit: <sup>1</sup>				
- washer	-	-	-	-
- incubator (water-bath)	-	-	+	-
- spectrophotometric reader	-	-	-	-
- refrigerator (storage)	+/-	+	+	+
- agitator , rocker	-	-	+	+
- aspiration device	-	-	+	+
- automatic pipette (µl)	+	+	+	+
- multichannel (µl)	-	-	-	-
- disposable tips	+	+	+	+
- dilution tubes/rack, microtiterplate	-	-	-	-
- distilled or deionised water	-	-	+	+
- plate covers	-	-	-	-
- graduated pipette; cylinder (ml)	-	-	+	+
- sulfuric acid/sodium hydroxide	-	-	-	-
- absorbent paper	-	-	+	+
- disinfectant	+	+	+	+
- gloves	+	+	+	+
- reagent trough	-	-	-	-
- timer	+	+	+	+
Definition of positive results	Clear control and test lines	Dots at control region C and test region T1 or T2 or dots at C, T1 and T2	At least 2 HCV bands having 1+ or greater reactivity	1 or more HCV lines of \$2+. At least two HCV lines of \$1+.
Definition of grey zone or indeterminate result	Not applicable	Not applicable	A single HCV band having \$1+ reactivity or hSOD band and one or more bands having \$1+ reactivity	A reactivity of 1+ or +/- on one HCV line with or without other HCV lines with a reactivity of +/-

<sup>1</sup> + : not provided in the kit but necessary to perform the test; - :provided in the kit or not necessary to perform the test; +/- : use is optional.

**Table 4a. Technician’s appraisal of the test kit**

NAME	Score	GENEDIA® HCV Rapid	4 <sup>th</sup> Generation HCV TRI-DOT	RIBA HCV 3.0	InnoLIA HCV Ab III Update
Number of steps in the test procedure: -1-2 steps -3-5 steps ->5 steps	6 3 1	1	3	1	1
Clarity of kit instructions: - good - needs improvement	2 1	2	2	2	2
Kit and reagent packaging and labelling: - good - needs improvement	2 1	2	2	2	2
Total (out of possible 10)	10	5	7	5	5
Comments on the test kit		Micropipette convenient and easy to use, different coloured droppers on washing solutions helpful.	Very simple to perform, clear and precise instructions.	Care must be taken when handling strips, forceps must always be used.	Care must be taken when handling strips, forceps must always be used.

**Table 4b. Calculation of ease of performance**

NAME	GENEDIA® HCV Rapid	4 <sup>th</sup> Generation HCV TRI-DOT	RIBA HCV 3.0	InnoLIA HCV Ab III Update
Need to prepare:				
-antigen	1 <sup>1</sup>	1	1	1
-substrate	1	1	0	0
-wash solution	1	1	0	0
-conjugate	1	1	1	0
-predilution of serum	1	1	1	1
Stability after dilution/opening: (expiry date = 1; less = 0)				
-antigen	1	1	1	1
-controls	1	1	1	1
-sample diluent	1	1	1	1
-conjugate	1	1	1	0
-substrate	1	1	0	0
-wash buffer	1	1	0	0
-sufficient reagents	1	1	1	1
-wash (yes =0; no = 1)	1	1	0	0
Item needed but not provided in the kit:				
-reagent trough	1	1	1	1
-automatic /multichannel pipette	0 <sup>2</sup>	0	0	0
-dilution – tubes, rack/microtiter plate	1	1	1	1
-distilled or deionised water	1	1	0	0
-plate covers	1	1	1	1
-graduated pipette, cylinder	1	1	0	0
-sulfuric acid/sodium hydroxide	1	1	1	1
Technician's appraisal of the test kit <sup>3</sup> (rating out of 10)	5	7	5	5
Total (out of possible 30)	24	26	17	15
Ease of performance:				
-less easy < 20				
-easy $20 \leq x \leq 25$	easy	very easy	less easy	less easy
-very easy > 25				

<sup>1</sup> 1 : positive rating: reagent needs no preparation; item provided in the kit

<sup>2</sup> 0 : negative rating: reagent needs preparation; item not provided in the kit

<sup>3</sup> see table 4a

**Table 5. Suitability for use in small laboratories**

NAME	Score	GENEDIA® HCV Rapid	4 <sup>th</sup> Generation HCV TRI-DOT	RIBA HCV 3.0	InnoLIA HCV Ab III Update
Sensitivity					
- 100%	5				
- 98 – 100%	3	3	5	5	5
- <98%	0				
Specificity					
- >98%	5				
- 95 – 98%	3	5	5	not tested	not tested
- <95%	0				
Incubation temperature					
- room t°	3	3	3	3	3
- other than room t°	1				
Shelf-life					
- >1 year	3				
- ≥ 6 months ≤ 1 year	2	2	2	2	2
- < 6 months	1				
Storage at					
- ambient t° possible (opened kit)	5				
- ambient t° possible (unopened kit)	2	5	1	1	1
- 2-8 °C required	1				
Price per test (US\$)					
- ≤ 1.0	3				
- ≤ 2.0	2	2	2	1	1
- > 2.0	1				
Ease of performance					
- very easy	5				
- easy	3	3	5	1	1
- less easy	1				
Rapidity of performance:1 serum					
- < 10 min	3				
- 10 – 30 min	2	3	3	1	1
- > 30 min	1				
Washer/agitator					
- not needed	3	3	3	1	1
- needed	1				
Reading					
- visual: inter-reader variability ≤ 3%	5				
: inter-reader variability > 3%	3	3	5	not applicable	not applicable
- reading equipment	1				
Total (out of possible 40)		32	34	min 16 / max 25	min 16 / max 25
Suitability for use in small laboratories:					
- less suitable < 23		very suitable	very suitable	less suitable / suitable	less suitable / suitable
- suitable 23 ≤ x ≤ 30					
- very suitable > 30					

**Group 2: ELISAs and reference assays**

**Table 6. General characteristics and operational aspects**

NAME	3 <sup>rd</sup> Generation HCV Microlisa	Innotest HCV Ab III	Innotest® HCV Ab IV	Ortho HCV 3.0 Enhanced SAve	Monolisa anti-HCV PLUS
Company	J. Mitra & Co. Ltd., New Delhi, India	Innogenetics, Ghent, Belgium	Innogenetics, Ghent, Belgium	Ortho-Clinical Diagnostics, Inc., Raritan, USA	Bio-Rad, Marnes La Coquette, France
Assay type	indirect ELISA	indirect ELISA	indirect ELISA	indirect ELISA	indirect ELISA
Antibody type	polyclonal	polyclonal	polyclonal	monoclonal	polyclonal
Solid phase	microwells	polystyrene microplate strips	polystyrene microplate strips	microwells with recombinant encoded antigens	microwells with recombinant antigens
Specimen type	serum/plasma	serum/plasma	serum/plasma	serum/plasma	serum/plasma
Number of tests per kit (product code)	96 (HC022096) 192 (HC022192) 480 (HC022480)	96 (K1029) 480 (K1039)	96 (K1065) 480 (K1079)	192 (930820) 480 (930800)	96 (72312) 480 (72313)
Lot numbers evaluated (expiry date)	ECV02021 (Oct. '01)	80424051 (June '99) 00117580 (Apr. '01)	00615697 (Apr. '01)	GECV598 (Feb. '00)	8M533Q (Nov. '99)
Shelf life at (°C)	9 months (4 - 8)	13 months (2 - 8)	13 months (2 - 8)	12 months (2-8)	12 months (2-8)
Volume of serum needed (µL) Final dilution of serum	10 1/11	10 1/21	20 1/11	20 1/11	20 1/5
Total time to perform the assay: h. min (number of sera)	2.20 (89 + 7 controls)	3.20 (92 + 4 controls)	3.20 (91 + 4 controls + 1 blank well)	2.40 (90 + 5 controls + 1 blank well)	2.10 (91 + 5 controls)
Reading	492nm 600 – 650nm as reference	450nm 690 or 620nm as reference	450nm 620nm as a reference	450nm 620 or 630nm as reference	450nm 620nm as a reference
Price/test (US\$)	0.90 (96 tests/kit) 0.80 (192 tests/kit) 0.75 (480 tests/kit)	not available	not available	3.00	3.00



**Table 7. Comparison of the assays with reference tests**

NAME	3 <sup>rd</sup> Generation HCV Microlisa	Innotest HCV Ab III	Innotest® HCV Ab IV	Ortho HCV 3.0 Enhanced SAVe	Monolisa anti-HCV PLUS
Final Sensitivity % (95 CL)* n = 68	100.0 (94.7 – 100.0)	100.0 (94.7 – 100.0)	100.0 (94.7 – 100.0)	100.0 (94.7 – 100.0)	100.0 (94.7 – 100.0)
Initial Specificity % (95 CL)*	96.8 (93.2 – 98.8)	99.5 (97.1 – 100.0)	100.0 (98.1 – 100.0)	98.9% (96.2 – 99.9)	99.5% (97.1 – 100.0)
Final Specificity % (95 CL)* n = 189	97.4 (93.9 – 99.1)	100.0 (98.1 – 100.0)	100.0 (98.1 – 100.0)		
Indeterminate results%	0.0	0.0	0.0	0.0	0.0
Initial inter-reader variability%	not applicable	not applicable	not applicable	not applicable	not applicable
PPV 0.1%	28.0	66.9	100	47.8	66.9
5.0%	66.9	91.3	100	82.7	91.3
10.0%	81.0	95.7	100	91.0	95.7
NPV 0.1%	100.0	100.0	100.0	100.0	100.0
5.0%	100.0	100.0	100.0	100.0	100.0
10.0%	100.0	100.0	100.0	100.0	100.0

\* 95 % Confidence Limits

**Table 8. Detailed operational aspects**

NAME	3 <sup>rd</sup> Generation HCV Microlisa	Innotest HCV Ab III	Innotest® HCV Ab IV	Ortho HCV 3.0 Enhanced SAve	Monolisa anti-HCV PLUS
Dimension (cm) of kit : w-l-h	12.8-19.0-9.0 (96 tests) 19.0-25.7-9.0 (192 tests) 32.0-39.0-9.0 (480 tests)	17.7-23.9-7.9 (96 tests)	16.45-13.5-12.0 (96 tests)	16.5-23.0-16.0	22.8-25.3-14.0
Storage conditions (°C)	4 – 8	2 – 8	2 - 8	2 - 8	2 - 8
Incubation temperature (°C)	37 sample & conjugate 20-25 substrate	37 sample & conjugate 20-25 substrate	37 sample & conjugate 18-30 substrate	37 sample & conjugate 15-30 substrate	37 sample & conjugate 18-30 substrate
Reading endpoint stability (h.min)	not stated	0.15	0.15	1.00	0.30
Stability after dilution/ reconstitution/opening at (°C)					
- antigen	expiry date (4 – 8)	8 weeks (2 – 8)	8 weeks (2 – 8)	expiry date (2 – 8)	expiry date (2 – 8)
- controls	expiry date (4 – 8)	expiry date (2 – 8)	expiry date (2 – 8)	expiry date (2 – 8)	expiry date (2 – 8)
- sample diluent	expiry date (4 – 8)	expiry date (2 – 8)	expiry date (2 – 8)	expiry date (2 – 8)	expiry date (2 – 8)
- conjugate	4 hours (4 - 8)	8 hours (room t, in dark)	8 hours (2 - 8)	expiry date (2 – 8)	expiry date (2 – 8)
- substrate	expiry date (4 – 8)	1 hour (room t, in dark)	1 hour (room t, in dark)	1 hour (room t, in dark)	6 hours (room t, in dark)
- wash buffer	2 months (4 – 8)	2 weeks (2 - 8)	4 weeks (2 - 8)	2 months (2 – 8)	2 weeks (2 – 8)
Number of sera per run minimum – maximum	1 - 90	1 - 92	1 - 91	1 - 90	1 - 91
Number of controls per test run	5	4	4	5	5
- negative	2	2	2	3	2
- cut-off/weak positive	0	0	0	0	0
- positive	3	2	2	2	3
- blank	1	0	0	1	0
internal control: reagent control	yes	yes	yes	yes	yes
: sample addition control	no	no	yes	yes	yes

**Table 8. (continued) Detailed operational aspects**

NAME	3 <sup>rd</sup> Generation HCV Microlisa	Innotest HCV Ab III	Innotest® HCV Ab IV	Ortho HCV 3.0 Enhanced SAve	Monolisa anti-HCV PLUS
Estimated time to perform one run: h.min (minimum number of sera) h.min (maximum number of sera)	1.55 (1) 2.20 (89)	2.50 (1) 3.25 (92)	2.50 (1) 3.25 (91)	2.50 (1) 3.30 (90)	2.15 (1) 3.00 (91)
Equipment needed but not provided in the kit: <sup>1</sup>					
- washer	+	+	+	+	+
- incubator (water-bath)	+	+	+	+	+
- spectrophotometric reader	+	+	+	+	+
- refrigerator (storage)	+	+	+	+	+
- agitator, rocker, tray mixer	-	-	-	-	-
- aspiration device	-	-	-	-	-
- automatic pipette (µl)	+	+	+	+	+
- multichannel (µl)	+/-	+/-	+/-	+/-	+/-
- disposable tips	+	+	+	+	+
- dilution tubes/rack, microtiterplate	-	-	-	-	-
- distilled or deionised water	+	+	+	+	+
- plate covers	-	-	-	-	-
- graduated pipette; cylinder (ml)	+	+	+	+	+
- sulfuric acid/sodium hydroxide	-	-	-	-	-
- absorbent paper	-	-	-	-	-
- disinfectant	+	+	+	+	+
- gloves	+	+	+	+	+
- reagent trough	-	-	-	+/-	+/-
- timer	+	+	+	+	+
Definition of positive results	Test sample OD/CO \$1	Test sample OD/CO \$1	Test sample OD/CO \$1	Test sample OD/CO \$1	Test sample OD/CO \$1
Definition of grey zone	None	None	None	None	OD of sample is <1 and >0.9 x CO value

<sup>1</sup> + : not provided in the kit but necessary to perform the test; - : provided in the kit or not necessary to perform the test; +/- : use is optional.

**Table 9a. Technician's appraisal of the test kits**

NAME	Score	3 <sup>rd</sup> Generation HCV Microlisa	Innotest HCV Ab III	Innotest® HCV Ab IV	Ortho HCV 3.0 Enhanced SA Ve	Monolisa anti-HCV PLUS
Number of steps in the test procedure: -1-2 steps -3-5 steps ->5 steps	6 3 1	1	1	1	1	1
Clarity of kit instructions: - good - needs improvement	2 1	2	2	2	2	2
Kit and reagent packaging and labelling: - good - needs improvement	2 1	2	2	2	2	2
Total (out of 10)		5	5	5	5	5
Comments on the test kit		Very easy to perform, colour change expected with sample addition is very slight due to small sample size	Similar size and colour containers may be confusing	Sample addition colour change is not sufficient	Sample addition colour change good and coloured conjugate reagent allows addition monitoring	Sample addition colour change good and coloured conjugate reagent allows addition monitoring

**Table 9b. Calculation of ease of performance**

NAME	3 <sup>rd</sup> Generation HCV Microlisa	Innotest HCV Ab III	Innotest® HCV Ab IV	Ortho HCV 3.0 Enhanced SAve	Monolisa anti-HCV PLUS
Need to prepare:					
-antigen	1 <sup>1</sup>	1	1	1	1
-substrate	0 <sup>2</sup>	0	0	0	0
-wash solution	0	0	0	0	0
-conjugate	0	0	0	1	1
-predilution of serum	0	1	1	1	1
Stability after dilution/opening: (expiry date = 1; less = 0)					
-antigen	1	1	1	1	1
-controls	1	1	1	1	1
-sample diluent	1	1	1	1	1
-conjugate	0	0	0	1	1
-substrate	0	0	0	0	0
-wash buffer	1	1	1	1	1
-sufficient reagents	1	1	1	1	1
-wash (yes =0; no = 1)	1	1	1	1	1
Item needed but not provided in the kit:					
-reagent trough	0	0	0	0	0
-automatic /multichannel pipette	0	0	0	0	0
-dilution – tubes, rack/microtiter plate	0	1	1	1	1
-distilled or deionised water	0	0	0	0	0
-plate covers	1	1	1	1	1
-graduated pipette ,cylinder	0	0	0	0	0
-sulfuric acid/sodium hydroxide	1	1	1	1	1
Technician's appraisal of the test kit <sup>3</sup> (rating out of 10)	5	5	5	5	5
Total (out of possible 30)	14	16	16	18	18
Ease of performance:					
-less easy < 20					
-easy $20 \leq x \leq 25$	less easy	less easy	less easy	less easy	less easy
-very easy > 25					

<sup>1</sup> 1 : positive rating: reagent needs no preparation; item provided in the kit.

<sup>2</sup> 0 : negative rating: reagent needs preparation; item not provided in the kit

<sup>3</sup> : see table 9a

**Table 10. Suitability for use in small laboratories**

NAME	Score	3 <sup>rd</sup> Generation HCV Microlisa	Innotest HCV Ab III	Innotest® HCV Ab IV	Ortho HCV 3.0 Enhanced SA Ve	Monolisa anti-HCV PLUS
Sensitivity						
- 100%	5					
- 98 – 100%	3	5	5	5	5	5
- <98%	0					
Specificity						
- >98%	5					
- 95 – 98%	3	3	5	5	5	5
- <95%	0					
Incubation temperature						
- room t°	3	1	1	1	1	1
- other than room t°	1					
Shelf-life						
- >1 year	3					
- ≥ 6 months ≤ 1 year	2	2	3	3	3	3
- < 6 months	1					
Storage at						
- room t° possible opened kit	5					
- room t° possible unopened kit	2	1	1	1	1	1
- 2-8 °C required	1					
Price per test (US\$)						
- ≤ 1.0	3					
- ≤ 2.0	2	3	1	1	1	1
- > 2.0	1					
Ease of performance						
- very easy	5					
- easy	3	1	1	1	1	1
- less easy	1					
Rapidity of performance:1 serum						
- < 10 min	3					
- 10 – 30 min	2	1	1	1	1	1
- > 30 min	1					
Washer/agitator						
- not needed	3	1	1	1	1	1
- needed	1					
Reading						
- visual: inter-reader variability ≤ 3	5					
: inter-reader variability > 3	3	1	1	1	1	1
- reading equipment	1					
Total (out of 40)		19	20	20	20	20
Suitability for use in small laboratories:						
- less suitable < 23		less suitable	less suitable	less suitable	less suitable	less suitable
- suitable 23 ≤ x ≤ 30						
- very suitable > 30						

**Table 11. Results on seroconversion panels**

Panel ID	Bleed Date	Days since first bleed	PCR <sup>1</sup> copies/ml	SR1	SR2	IB1 <sup>1</sup>	IB2	ELISA1	ELISA2	ELISA3	ELISA4	ELISA5	
PHV907	-01	06.04.96	0	>5x10 <sup>5</sup>	neg	neg	neg	neg	0.1	0.1	0.0	0.1	0.1
	-02	10.04.96	4	>5x10 <sup>5</sup>	neg	neg	neg	neg	0.1	0.1	0.0	0.1	0.1
	-03	13.04.96	7	>5x10 <sup>5</sup>	neg	neg	neg	neg	0.1	0.0	0.0	0.1	0.1
	-04	19.04.96	13	>5x10 <sup>5</sup>	pos	pos	ind	pos	0.6	<b>1.4</b>	<b>2.4</b>	0.3	0.2
	-05	24.04.96	18	>5x10 <sup>5</sup>	pos	pos	ind	pos	<b>1.5</b>	3.7	3.2	<b>1.8</b>	0.9
	-06	27.04.96	21	>5x10 <sup>5</sup>	pos	pos	pos	pos	1.4	4.0	4.1	2.9	<b>1.3</b>
	-07	17.09.96	164	4x10 <sup>4</sup>	pos	pos	pos	pos	4.2	8.6	4.7	8.2	7.8
PHV908	-01	26.01.96	0	2x10 <sup>5</sup>	neg	neg	neg	neg	0.1	0.0	0.0	0.1	0.1
	-02	29.01.96	3	3x10 <sup>5</sup>	neg	neg	neg	neg	0.1	0.1	0.0	0.1	0.1
	-03	31.01.96	5	3x10 <sup>5</sup>	neg	neg	neg	neg	0.1	0.0	0.0	0.1	0.1
	-04	06.02.96	11	1x10 <sup>5</sup>	neg	neg	neg	ind	0.1	0.0	0.0	0.6	0.1
	-05	08.02.96	13	2x10 <sup>5</sup>	neg	neg	pos	pos	0.1	0.0	0.0	0.7	0.2
	-06	14.02.96	19	1x10 <sup>5</sup>	neg	neg	pos	pos	0.1	0.1	0.3	<b>2.2</b>	0.8
	-07	20.02.96	25	5x10 <sup>4</sup>	neg	neg	pos	pos	0.2	0.1	<b>1.8</b>	3.8	<b>4.5</b>
	-08	22.02.96	27	8x10 <sup>4</sup>	neg	neg	pos	pos	0.4	0.0	2.0	4.7	5.6
	-09	27.02.96	32	1x10 <sup>5</sup>	neg	neg	pos	pos	0.8	0.1	3.1	5.8	7.3
	-10	01.03.96	35	2x10 <sup>4</sup>	ind	ind	pos	pos	<b>1.1</b>	0.3	2.5	6.3	7.4
	-11	07.03.96	41	2x10 <sup>4</sup>	neg	ind	pos	pos	1.5	0.2	3.4	7.2	8.2
	-12	11.03.96	45	2x10 <sup>4</sup>	pos	pos	pos	pos	1.7	0.3	3.5	7.2	8.5
	-13	14.03.96	48	2x10 <sup>5</sup>	ind	neg	pos	pos	1.6	0.3	3.4	7.0	8.6
PHV911	-01	30.10.96	0	>5x10 <sup>5</sup>	neg	neg	neg	neg	0.1	0.1	0.0	0.0	0.0
	-02	02.11.96	3	>5x10 <sup>5</sup>	neg	neg	neg	neg	0.2	0.1	0.0	0.0	0.1
	-03	13.11.96	14	>5x10 <sup>5</sup>	pos	neg	pos	pos	<b>1.4</b>	<b>4.0</b>	<b>2.0</b>	<b>1.5</b>	<b>1.0</b>
	-04	20.11.96	21	>5x10 <sup>5</sup>	pos	pos	pos	pos	2.9	7.3	3.9	6.9	6.9
	-05	23.11.96	24	>5x10 <sup>5</sup>	pos	pos	pos	pos	2.5	6.6	4.0	7.2	8.9
PHV913	-01	27.02.97	0	>5x10 <sup>5</sup>	neg	neg	neg	ind	0.1	0.2	0.5	0.0	0.1
	-02	01.03.97	2	>5x10 <sup>5</sup>	ind	neg	neg	ind	0.4	<b>1.2</b>	<b>2.4</b>	0.1	0.3
	-03	06.03.97	7	>5x10 <sup>5</sup>	pos	pos	ind	pos	<b>1.6</b>	4.9	4.1	<b>1.5</b>	<b>3.0</b>
	-04	08.03.97	9	>5x10 <sup>5</sup>	pos	pos	ind	pos	1.8	5.0	4.4	1.7	2.9

<sup>1</sup>Data supplied by Boston Biomedica Inc.

PCR : HCV RNA Roche Amplicor PCR

SR1 : GENEDIA® HCV Rapid ( Green Cross Life Science Corp.)

SR2 : 4<sup>th</sup> Generation HCV TRI-DOT (J. Mitra & Co. Ltd.)

<sup>1</sup>IB1 : CHIRON® RIBA® HCV 3.0 (Chiron) (used as reference assay)

IB2 : INNO-LIA™ HCV Ab III update (Innogenetics) (used as reference assay)

nt – not tested

blt – below limit of detection

ELISA1 : 3<sup>rd</sup> Generation HCV Microlisa (J. Mitra & Co. Ltd.)

ELISA2 : Innostest HCV Ab III (Innogenetics)

ELISA3 : Innostest® HCV Ab IV (Innogenetics)

ELISA4 : Ortho HCV 3.0/Enhanced SAvE (Ortho-Clinical Diagnostics) (used as reference assay)

ELISA5 : Monolisa anti-HCV PLUS (Bio-Rad) (used as reference assay)

Table 12. Results on world-wide performance panel

Panel ID	Origin	Murex HCV <sup>1</sup> Serotyping 1-6	Innogenetics <sup>1</sup> INNO-LiPA	Expected Result	PCR <sup>1</sup> copies/ ml	SR1	SR2	IB1 <sup>1</sup>	IB2	ELISA1	ELISA2	ELISA3	ELISA4	ELISA5
WWHV301-01	Argentina	1	1b	pos	>5x10 <sup>5</sup>	pos	pos	pos	pos	4.8	9.8	5.1	8.2	9.3
-02	Argentina	nottypable	1b	pos	3x10 <sup>5</sup>	pos	pos	pos	pos	4.5	9.3	5.2	9.5	9.5
-03	Argentina	3	3a/b	pos	6x10 <sup>4</sup>	pos	pos	pos	pos	5.9	10.7	5.0	8.5	10.4
-04	Argentina	2	2a/c	pos	9x10 <sup>4</sup>	pos	pos	ind	pos	5.2	9.1	5.1	9.4	10.4
-05	Argentina	neg	not tested	neg	nt	neg	neg	neg	neg	0.2	0.1	0.0	0.0	0.0
-06	Uganda	4	4c/d	pos	4x10 <sup>3</sup>	pos	pos	pos	pos	4.3	6.9	4.9	7.4	11.8
-07	Uganda	2	nottypable	pos	bld*	pos	pos	pos	pos	2.5	6.4	3.9	7.6	8.3
-08	Ghana	neg	not tested	neg	nt**	neg	neg	neg	neg	1.0	0.0	0.0	0.1	0.2
-09	China	1	1b,2a/c	pos	3x10 <sup>3</sup>	pos	pos	pos	pos	4.4	8.4	4.8	8.0	9.8
-10	China	1	2	pos	4x10 <sup>3</sup>	pos	pos	pos	pos	6.1	9.8	5.3	8.9	11.4
-11	China	1	1b	pos	4x10 <sup>3</sup>	pos	pos	pos	pos	3.5	7.3	4.5	7.8	7.3
-12	China	2	2	pos	2x10 <sup>4</sup>	pos	pos	pos	pos	5.5	9.9	5.1	8.8	10.2
-13	China	1,2	1a/b, 2a/c	pos	1x10 <sup>5</sup>	pos	pos	pos	pos	5.0	10.5	5.0	9.4	11.0
-14	Egypt	3	3a	pos	1x10 <sup>5</sup>	pos	pos	pos	pos	4.8	7.2	4.5	8.9	9.5
-15	Egypt	4	4	pos	6x10 <sup>4</sup>	pos	pos	pos	pos	4.4	4.5	4.8	8.9	10.5
-16	Egypt	4	4h	pos	2x10 <sup>4</sup>	pos	pos	pos	pos	7.0	6.9	4.8	8.8	11.5
-18	USA	1	1b	pos	>5x10 <sup>5</sup>	pos	pos	pos	pos	2.8	4.8	5.2	8.6	9.4
-19	USA	nottypable	1a	pos	3x10 <sup>5</sup>	pos	pos	pos	pos	1.6	0.3	1.7	5.3	5.9
-20	USA	1	1a	pos	1x10 <sup>4</sup>	pos	pos	pos	pos	4.0	3.7	4.3	7.6	8.5

<sup>1</sup> data supplied by Boston Biomedica Inc.

\*bld – below limit of detection

\*\*nt – not tested

PCR : HCV RNA Roche Amplicor PCR

SR1 : GENEDIA® HCV Rapid ( Green Cross Life Science Corp.)

SR2 : 4<sup>th</sup> Generation HCV TRI-DOT (J. Mitra & Co. Ltd.)

IB1 : CHIRON® RIBA® HCV 3.0 (Chiron) (used as reference assay)

IB2 : INNO-LIA™ HCV Ab III update (Innogenetics) (used as reference assay)

ELISA1 : 3<sup>rd</sup> Generation HCV Microlisa (J. Mitra & Co. Ltd.)

ELISA2 : Innotest HCV Ab III (Innogenetics)

ELISA3 : Innotest® HCV Ab IV (Innogenetics)

ELISA4 : Ortho HCV 3.0/Enhanced SAv<sub>e</sub> (Ortho-Clinical Diagnostics) (used as reference assay)

ELISA5 : Monolisa anti-HCV PLUS (Bio-Rad) (used as reference assay)

Note: Sample WWHV301-17 was deleted from the analysis because the RIBA result was indeterminate and the PCR was below the limit of detection



**Table 13. Results on low titre performance panel**

Panel ID	Expected Result	PCR copies /ml <sup>1</sup>	SR1	SR2	IB1 <sup>1</sup>	IB2	ELISA1	ELISA2	ELISA3	ELISA4	ELISA5
PHV104-01	POS	bld*	<b>ind</b>	pos	pos	pos	2.1	3.4	2.0	1.9	<b>0.6</b>
-02	POS	1x10 <sup>5</sup>	pos	pos	pos	pos	4.2	5.6	5.3	9.0	12.3
-04	POS	6x10 <sup>5</sup>	pos	<b>ind</b>	pos	pos	3.8	2.7	4.5	9.0	10.7
-05	POS	1x10 <sup>5</sup>	pos	pos	pos	pos	1.2	3.7	3.1	2.4	<b>0.7</b>
-06	POS	1x10 <sup>5</sup>	pos	pos	pos	pos	3.6	2.9	5.2	8.1	11.0
-07	POS	1x10 <sup>4</sup>	<b>neg</b>	pos	pos	pos	3.3	2.6	4.2	7.8	8.4
-08	POS	bld	<b>neg</b>	<b>ind</b>	pos	pos	1.1	1.3	1.5	1.8	2.8
-09	POS	bld	<b>neg</b>	pos	pos	pos	2.4	<b>0.9</b>	2.3	3.7	3.5
-10	POS	2x10 <sup>4</sup>	<b>neg</b>	pos	<b>ind</b>	pos	2.3	<b>0.6</b>	2.2	4.4	4.5
-11	POS	bld	<b>neg</b>	pos	pos	pos	2.7	1.0	1.7	2.1	2.2
-12	NEG	nt	neg	neg	neg	neg	0.4	0.1	0.0	0.1	0.0
-13	POS	2x10 <sup>4</sup>	pos	pos	pos	pos	2.4	1.3	<b>0.8</b>	2.5	2.0
-14	POS	bld	<b>ind</b>	pos	pos	pos	1.5	1.6	1.6	2.8	3.2
-15	POS	1x10 <sup>5</sup>	pos	pos	pos	pos	2.8	<b>0.4</b>	2.9	7.1	8.2

<sup>1</sup> data supplied by Boston Biomedica Inc.

\*bld – below limit of detection

\*\*nt – not tested

PCR : HCV RNA Roche Amplicor PCR

SR1 : GENEDIA® HCV Rapid ( Green Cross Life Science Corp.)

SR2 : 4<sup>th</sup> Generation HCV TRI-DOT (J. Mitra & Co. Ltd.)

IB1 : CHIRON® RIBA® HCV 3.0 (Chiron) (used as reference assay)

IB2 : INNO-LIA™ HCV Ab III update (Innogenetics) (used as reference assay)

ELISA1 : 3<sup>rd</sup> Generation HCV Microlisa (J. Mitra & Co. Ltd.)

ELISA2 : Innostest HCV Ab III (Innogenetics)

ELISA3 : Innostest® HCV Ab IV (Innogenetics)

ELISA4 : Ortho HCV 3.0/Enhanced SAve (Ortho-Clinical Diagnostics) (used as reference assay)

ELISA5 : Monolisa anti-HCV PLUS (Bio-Rad) (used as reference assay)

Note: Sample PHV104 – 3 was deleted from the analysis because the RIBA result was indeterminate and the PCR was below limit of detection

Explanatory notes for Tables 1-13 and Figures 1-2

<b>Tables 1 and 6</b>	<b>General characteristics and operational aspects of the assays.</b>
Specimen type	The HCV TRI-DOT (J Mitra & Co. Ltd) may be used with human serum only, the remaining four kits under evaluation may be used with human serum or plasma samples. The volumes of serum required for each assay was between 10 and 50µl.
Shelf life at (°C)	Only one kit, the Genedia HCV Rapid could be stored at room temperature, the remaining four kits required storage at 2 - 8°C.
Final dilution of the serum	is the dilution of the serum in the test format, e.g. 10µl serum added to 200µl diluent gives a final dilution of 1/21.
Total time to perform the assay	reflects the time needed to carry out 1 test run, i.e. the most economical use of the technique. <ul style="list-style-type: none"><li>- simple/rapid assays designed for individual tests: the number which can be run simultaneously</li><li>- ELISA tests: the number of test samples that may be run on a whole microtitre plate</li><li>- line assays: the number of samples that can be run on a complete kit</li></ul>
Price/test	as given at the time of the evaluation by the manufacturer, or converted to USD using the currency conversion rate at the time. The prices stated are the catalogue prices and therefore indicative.
<b>Tables 2 and 7.</b>	<b>Comparison of the results of the assays with reference tests</b>
Sensitivity	calculated as described on page 9 of this document.
Specificity	calculated as described on page 9 of this document.
95% Confidence limits (CL)	calculated as described on page 9 of this document
PPV and NPV	calculated as described on page 10 of this document
Indeterminate results	Simple/rapid assays - test results which could not be interpreted as clearly positive or negative were considered indeterminate.
Inter-reader variability	calculated as described on page 10 of this document.

Explanatory notes for Tables 1-13 and Figures 1-2

**Tables 3 and 8.**

**Detailed operational aspects of the assay**

minimum - maximum number of sera

- minimum number = 1 sample in addition to the required controls
- maximum number = the maximum number of samples in addition to the required controls which can be simultaneously tested within the limits of the assay procedure.

Number of controls per test run  
Internal control

The following assay has a control spot or line on the test devices which checks that sample has been added, the procedure is followed correctly and reagents function correctly: 4th Generation HCV TRI-DOT (J. Mitra & Co. Ltd.).

The following assay has a control spot or line on the test devices which check that reagents function correctly and the procedure has been correctly followed: Genedia HCV Rapid (Green Cross Life Science Corp.)

All the ELISA assays, 3<sup>rd</sup> Generation HCV Microelisa (J. Mitra & Co. Ltd), Innotest HCV Ab III and Innotest HCV Ab IV (Innogenetics), contain positive and negative controls but only the Innotest HCV Ab IV incorporates a sample addition colour change control.

The number of controls shows the number of replicates of each control required for each assay run. For the internal controls the reagent control is normally shown by the addition of a coloured reagent and the sample addition control shows a colour change.

Definition of positive results

a sample is interpreted as positive according to the criteria set by the manufacturer and summarized in the table

**Tables 4a, 4b and 9a, 9b.**

**Calculation of ease of performance of the assay**

The criteria for this calculation are given in the respective tables.

**Tables 5 and 10.**

**Suitability of the assay for use in small laboratories**

The criteria for this calculation are given in the respective tables.

Note

These criteria are primarily technical and while an assay may be regarded as “technically” suitable for use in laboratories with limited facilities or where small numbers of samples are routinely tested, the sensitivity and specificity of the assay are over-riding factors in determining the suitability of an assay for use in any laboratory.

Explanatory notes for Tables 1-13 and Figures 1-2

<b>Table 11.</b>	<b>Performance of the assay on seroconversion panels</b> An assay's performance on the seroconversion panels should be viewed against both the sensitivity and specificity of the assay. Assays of relatively low specificity may appear to detect antibody to HCV earlier than other assays of higher specificity. Caution should be taken when reviewing seroconversion performance of assays tested only in 4 panels.
<b>Table 12.</b>	<b>Results of the assays on world-wide performance panel</b> A world panel including different genotypes was tested in each assay. Any results which were different from the expected results are shown in bold type. Sample WWHV301-17 was deleted from the analysis because the RIBA result was indeterminate and the PCR was below limit of detection.
<b>Table 13.</b>	<b>Results of the assays on a low titre panel</b> A panel of samples with low anti-HCV titre were tested in each assay. Any results which were different from the expected results are shown in bold type. Sample PHV104-3 was deleted from the analysis because the RIBA result was indeterminate and the PCR was below limit of detection.
<b>Figure 1.</b>	<b>Relative performance on seroconversion panels</b> Four seroconversion panels (BBI), each containing several samples taken at different time intervals early in the infection period (window period), were tested with the simple and/or rapid anti-HCV test kits. The results obtained with these assays were compared to those of the combined outcome of the Ortho HCV 3.0 Enh. SA Vc reference test (see page 27 of this report); the difference in days of the first sample of a panel to become positive with test X as compared to the first positive result with the reference test. If a test gave a positive result earlier than the reference test the number of days difference in detection were rated as negative; if the test became positive later the number of days were rated as positive. The mean of the difference in time period for a test to become positive as compared to the reference test was calculated and plotted on a yardstick. The 95% confidence limits of the mean were also calculated. These limits should be interpreted with caution as only 4 panels were tested.
<b>Figure 2.</b>	<b>Relative performance of the assays on seroconversion, world-wide performance and low titre panels</b> Assay performance was compared on the three types of panels by summing the number of samples identified as positive on the seroconversion panels and summing the number of samples correctly identified as positive in the world-wide and low titre panels. The maximum possible number of correctly identified specimens was 14 for the low titre panel and 19 for the world-wide panel.

**Figure 1. Relative performance in seroconversion panels as compared to the reference assay (Ortho HCV 3.0 Enhanced SAve)**

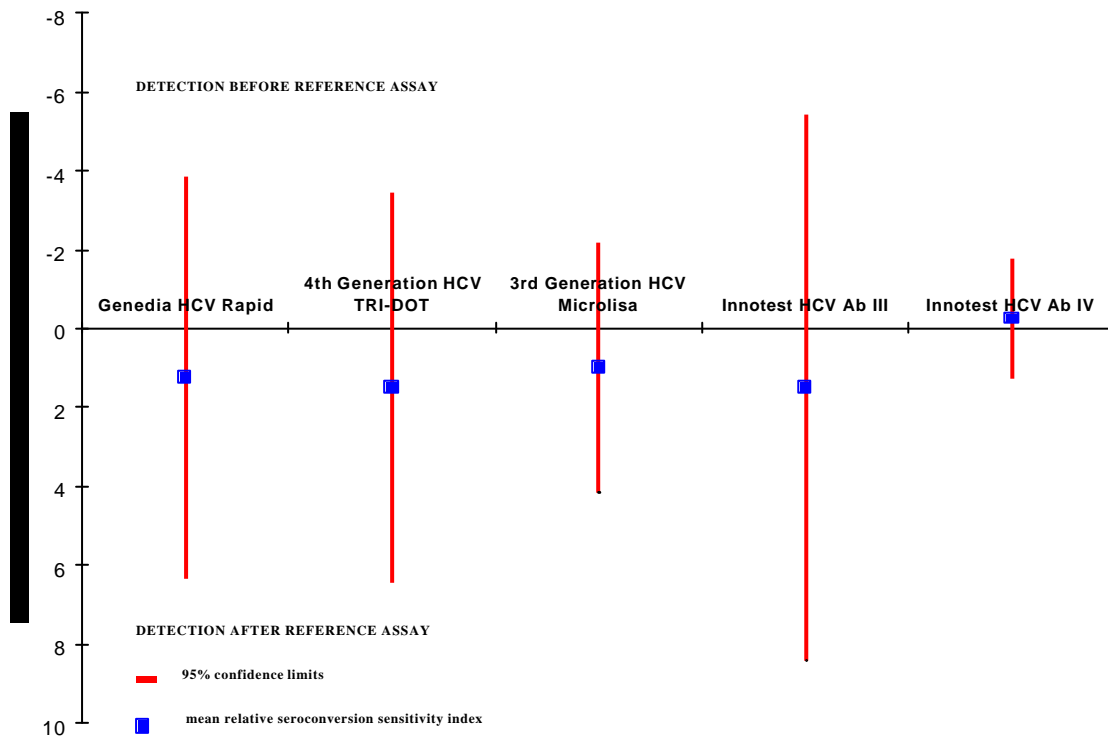
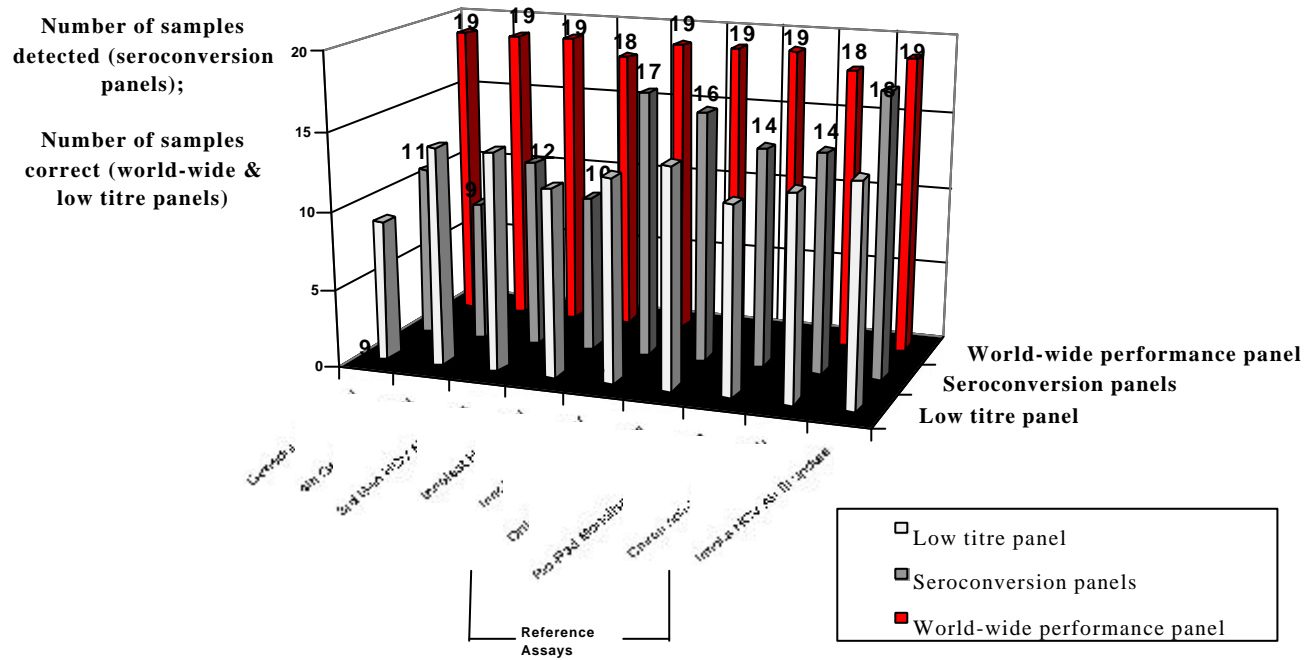
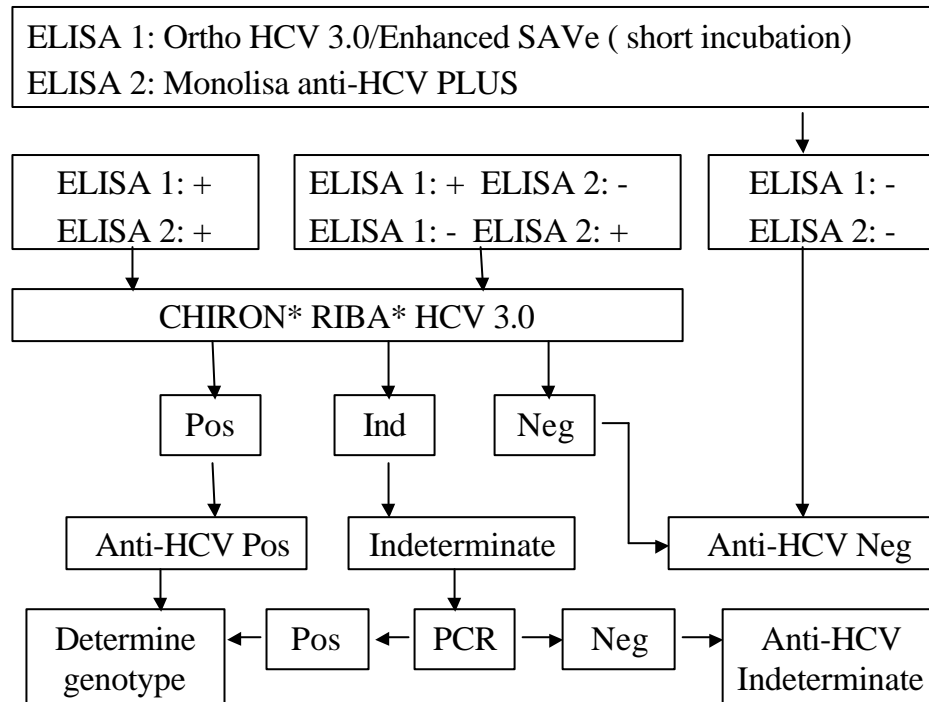

Figure 2. Relative performance in seroconversion, world-wide and low titre panels



## 6. ANNEXES

### ANNEX 1. Algorithm for characterization of the WHO HCV panel



## ANNEX 2. Cumulative list of assays evaluated; currently commercially available

The names (and companies) of the anti-HCV assays evaluated to date under the WHO programme are listed in the table below. The number of the report in which each assay is covered is given, as well as cost per test, sensitivity and specificity with 95% confidence intervals, indeterminate results, initial inter-reader variability, ease of performance and suitability for use in small blood collection centres.

Assay (Company)	Report No <sup>a</sup>	Price/test <sup>b</sup> US\$ (year)	Sensitivity <sup>c</sup> (%) <sup>e</sup>	Specificity <sup>d</sup> (%) <sup>e</sup>	Indeterminate results <sup>f</sup> (%)	Inter-reader variability <sup>g</sup> (%)	Ease of performance <sup>h</sup>	Storage conditions <sup>i</sup> (°C)
<b>Simple/Rapid tests</b>								
Advanced Quality™ One Step HCV Test (Bionike Inc.)	1	1.20 (99)	97.1 (89.8 - 99.6)	96.3 (92.5 - 98.5)	1.2	8.2	VE	2-30
HCV TRI-DOT (J. Mitra & Co. Ltd.)	1	2.00 (99)	100.0 (94.7 - 100.0)	91.5 (86.6 - 95.1)	3.1	15.6 (test spot 1) 3.1 (test spot 2)	VE	2-8
Serodia® HCV (Fujirebio Inc.)	1	4.50 (99)	100.0 (94.7 - 100.0)	99.5 (97.1 - 100.0)	0.0	0.8	E	2-10
HCV SP•T (Genelabs Diagnostics Pte Ltd.)	1	2.50 (99)	100.0 (94.7 - 100.0)	93.7 (89.2 - 96.7)	1.9	6.2	E	25 " 3
SeroCard™ HCV (Trinity Biotech plc)	1	2.25 (99)	98.5 (92.1 - 100.0)	100.0 (98.1 - 100.0)	0.0	4.7	E	2-8
Genedia® HCV Rapid (Green Cross Life Science Corp.)	2	0.75 (00)	98.5 (92.1 - 100.0)	98.4 (95.4 - 99.7)	1.6	5.1	E	2-30
4 <sup>th</sup> Generation HCV TRI-DOT (J. Mitra & Co. Ltd)	2	2.00 (00)	100.0 (94.7 - 100.0)	98.9 (96.2 - 99.9)	0.0	0.4	VE	4-8
CHIRON* RIBA* HCV 3.0 (Chiron) (used as reference test)	2	1.00 (00)	100.0 (94.7 - 100.0)	not tested	0.0	not applicable	LE	2-8
INNO-LIA™ HCV Ab III update (Innogenetics) (used as reference test)	2	0.63 (00)	100.0 (94.7 - 100.0)	not tested	0.0	not applicable	LE	2-8



<b>ELISA tests</b>								
3 <sup>rd</sup> Generation HCV Microlisa (J. Mitra & Co. Ltd)	2	0.90 (00)	100.0 (94.7 – 100.0)	97.4 (93.9 – 99.1)	0.0	not applicable	LE	4-8
Innotest HCV Ab III (Innogenetics)	2	not available	100.0 (94.7 – 100.0)	100.0 (98.1 – 100.0)	0.0	not applicable	LE	2-8
Innotest HCV Ab IV (Innogenetics)	2	not available	100.0 (94.7 – 100.0)	100.0 (98.1 – 100.0)	0.0	not applicable	LE	2-8
Ortho HCV 3.0 Enhanced SAve (Ortho-Clinical Diagnostics) (used as reference test)	2	0.35 (00)	100.0 (94.7 – 100.0)	98.9 (96.2 – 99.9)	0.0	not applicable	LE	2-8
Monolisa anti-HCV PLUS (Bio-Rad) (used as reference test)	2	0.70 (00)	100.0 (94.7 – 100.0)	99.5 (97.1 – 100)	0.0	not applicable	LE	2-8

## Legend for Annex 2.

- a: Operational Characteristics of Hepatitis C Assays (PHASE I) Report 1, January 2001.
- b: Prices are those quoted by the manufacturer at the time of the evaluation. The prices stated are the catalogue prices and therefore indicative.
- c, d, e: Sensitivity, specificity and 95% confidence limits were calculated as described on page 9 of this document.
- f: Indeterminate results were calculated as described in the explanatory notes on page 30 of this document.
- g: Inter-reader variability was calculated as described on page 10 of this document.
- h: Ease of performance is defined in Tables 4b and 9b.
- i: Storage conditions listed are for unopened kits. See Tables 3 and 8 for storage conditions of opened kits.

**Annex 3. Cumulative list of assay manufacturers' addresses**

**Bio-Rad**, 3, boulevard Raymond Poincaré, 92430 Marnes La Coquette, France.  
Tel: + 33 1 47 95 60 00; Fax: + 33 1 47 41 91 33; Website: www.bio-rad.com

**Bionike Inc.**, 1015 Grandview Drive, So. San Francisco, CA, 94080-4910 USA.  
Tel: +1 415 737 7937; Fax: +1 650 737 5902; Website: www.bionike.com

**Chiron Corporation**, 4560 Horton Street, Emeryville, CA 94608 USA.  
Tel: +1 510 655 8730; Fax: +1 510 655 9910; Website: www.chiron.com

**Fujirebio Inc.**, FR Bldg., 62-5, Nihonbashi-Hamacho 2-Chome Chuo-Ku Tokyo 103-0007 Japan.  
Tel: +81 3 5695 9217; Fax: +81 3 5695 9231.  
Fujirebio Europe BV, Takkebijsters 69c, 4817 BL Breda, The Netherlands  
Tel: +31 76 571 0440; Fax: +31 76 587 2181; Email: febv@xs4all.nl

**Genelabs Diagnostics Pte. Ltd.**, 85, Science Park Drive, # 04-01 The Cavendish, Singapore  
Science Park, Singapore 118259.  
Tel: +65 775 0008; Fax +65 775 4536; Email: genelabs@pacific.net.sg  
Website: www.genelabs.com.sg  
Europe: Halle de Frêt, P. O. Box 1015, 1215 Geneva 15 Airport, Switzerland.  
Tel: +41 22 788 1908; Fax +41 22 788 1986; Email: salesgva@genelabs.ch

**Green Cross Life Science Corp.** 227-3, Gugal-li, Giheung-eup, Yongin-shi, 449-900, Kyonggi-do,  
Seoul, Korea.  
Tel: +82 31 260 9359; Fax: +82 31 260 9491

**Innogenetics N.V./S.A.**, Technologie Park 6, B-9052 Zwijnaarde, Gent, Belgium.  
Tel: +32 9 329 1623; Fax +32 9 245 7623; Website: www.innogenetics.com

**J. Mitra & Co. Ltd**, A-180, Okhla Industrial Area, Phase-1, New Delhi-110 020, India.  
Tel: +91 11 681 8971; Fax: +91 11 681 8970; Email: jmitra@ndb.vsnl.net.in

**Ortho Clinical Diagnostics N.V.**, Antwerpseweg 19/21, B-2340 Beerse, Belgium.  
Tel: +32 14 60 02 11; Fax: + 32 14 61 51 58

**Trinity Biotech plc**, IDA Business Park, Bray, Co. Wicklow, Ireland.  
Tel: +353 1276 9800; Fax: +353 1276 9888; Website: www.trinitybiotech.ie

## **7. REFERENCES**

Schreiber GB, Busch MP, Kleinman SH, Korelitz JJ. The risk of transfusion-transmitted viral infections. *N Engl J Med* 1996;334(26):1685-90.

Barrera JM, Francis B, Ercilla G, Nelles M, Achord D, Darner J, Lee SR. Improved detection of anti-HCV in post-transfusion hepatitis by a third-generation ELISA. *Vox Sang* 1995;68:15-18.

## **8. ADDITIONAL READING**

Additional information may be obtained by visiting the BCT section of the WHO website at [www.who.int/bct](http://www.who.int/bct) and following the links to Key Initiatives, HIV Diagnostics. In addition to general information on diagnostics, assay evaluation reports for HIV, HCV and HBV are available as well as details for the WHO HIV Test Kit Bulk Procurement Scheme.

## **9. ACKNOWLEDGEMENT**

We would like to thank Mrs S. Lloyd, National Blood Transfusion Service, Harare, Zimbabwe; Dr E. Vinelli, National Blood Transfusion Service, Tegucigalpa, Honduras; Dr S. Tanprasert, National Blood Transfusion Service, Bangkok, Thailand and Dr J. Parry, Central Public Health Laboratory, London, UK for supplying specimens to the WHO Hepatitis C evaluation panel.

We acknowledge the 3 companies, J. Mitra & Co. Ltd, Green Cross Pharmaceutical Benefit Management Corp and Innogenetics for supplying the test reagents free of charge.

\*\*\*