

APPROPRIATE TECHNOLOGY IN OPHTHALMOLOGY

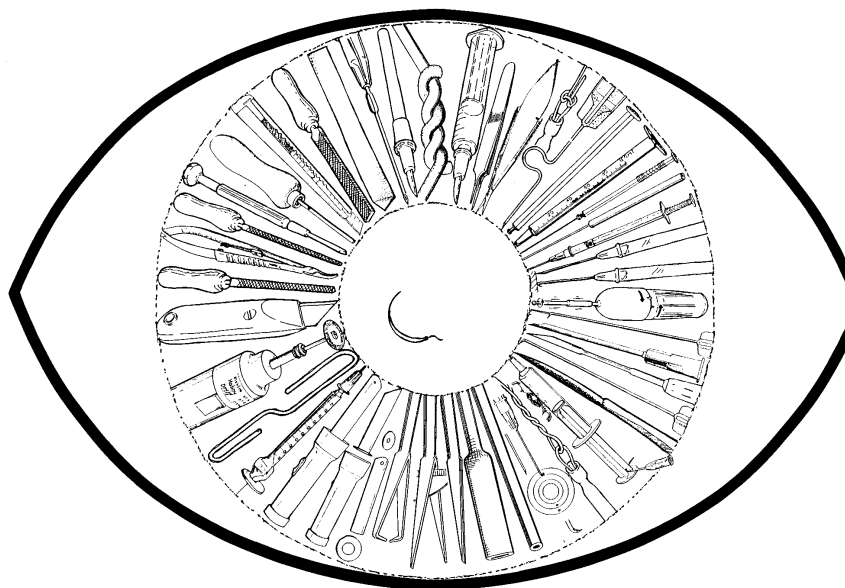

AN I.T.I.R. PUBLICATION

PREFACE

This book could be well the last activity of I.T.I.R. (Intermediate Technology Information Ring). This organisation was originally started in 1980, on a very small scale, by the initiative of Prof. Dr. Jan G.F. Worst.

The aim of I.T.I.R. was to inform doctors, working in the field of Ophthalmology, about the possibilities of using the locally available materials to improve the Ophthalmic health care in terms of quality, or in speed and cost-effectiveness.

To achieve this aim 'Newsletters' edited by Dr. Alke Rosbergen were sent to more than six hundred 'eye'-workers, most of whom were active in the third world.

In 1988 these 'Newsletters' were compiled and published under the name of 'Appropriate Technology in Ophthalmology'. This publication is now out of print.

After a total of thirty-four 'Newsletters' the interest to participate actively was fading away while Community Eye Health Journal started to be published regularly. Ideas can be ventilated there.

In tribute to Prof. Worst and his research group and all others involved in ITIR, a choice of edited 'Newsletters' are presented in this book.

Without the enthusiasm and computer work of Danny Haddad and the secretarial support of Mrs. Mees ten Oever-Ponds the book would not be there.

Reviewing of the text was done by M. Koch and P.J. de Lint.

Publication was made possible by a donation of the Tijssen Foundation.

May this book inspire those who are challenged to adapt their knowledge and skills under most adverse conditions.

Nico Buisman

Nico Dekkers

Danny Haddad

Peter Hardus, organisation

Koen Koppert

Kees van der Windt

october 1996

Correspondance:

P. Hardus, M.D.

F. C. Donders Institute For Ophthalmology

University Hospital Utrecht

P. O. Box 85500

3508 GA Utrecht

The Netherlands

CONTENTS

	Page
Part 1 Examination	
Chapter 1 Instruments from paperclip and stainless steel wire	2
Chapter 2 Tonometer	4
Chapter 3 Diagnostic tools	6
Chapter 4 Slitlamps	11
Chapter 5 Campimeter	13
Part 2 Knives and needles	
Chapter 6 Making ophthalmic surgical knives	14
Chapter 7 Making microsurgical needles and sutures	20
Part 3 Surgical instruments	
Chapter 8 Making an ITIR cryoextractor	25
Chapter 9 Making a cauter	33
Chapter 10 Surgical loupe	34
Chapter 11 Microscopes and surgical light	36
Chapter 12 Surgical stand for supporting facial drapes	36
Part 4 Surgical accessoires	
Chapter 13 Making sponges	37
Chapter 14 Eye shields	38
Chapter 15 Plastic operating sheets	40
Chapter 16 Intra Ocular Lenses "IOLs"	41
Part 5 Surgical procedures	
Chapter 17 Surgical technique for Vanadium Stainless steel 50 micron sutures	42
Chapter 18 Lowering intra-ocular pressure	48
Chapter 19 Anaesthesia in pediatric intra-ocular surgery	51
Chapter 20 Replacing cyclocryocoagulation by cyclothermocoagulation	52
Chapter 21 The prevention of infection in eye surgery	53
21.1 Surgical technique	
21.2 Sterile and disinfected instruments	
21.3 Clean surroundings and pre-and postoperative care	
Chapter 22 Chemical disinfection	62
22.1 Properties of disinfectants	
22.2 Acetone Box	
22.3 Additional remarks	

Part 6 Maintenance	Page
Chapter 23 Taking care of instruments	67
Chapter 24 Sharpening of a pair of scissors	68
Chapter 25 Repair of surgical instruments	72
25.1 General	
25.2 Micro surgical forceps	
25.3 Needle holders	
Part 7 Miscellaneous	
Chapter 26 Low Vision	75
Chapter 27 Drugs	76
Chapter 28 Solar equipment	77
Chapter 29 Training devices	78
Chapter 30 Literature	80
Chapter 31 Addresses	82
Index	85

Introduction

Surgery forms an important part of the therapeutic arsenal of ophthalmology. The number of patients which can be cured by surgery is relatively large.

A good example is cataract.

The high incidence of cataract especially in developing countries makes cataract surgery a very important goal of treatment in ophthalmology.

During the last decades, important technological changes have occurred. The more recent developments in cataract surgery all tend towards high sophistication in instrumentation and technique.

This sophistication with its high costs is not feasible in underprivileged circumstances.

To reduce costs in ophthalmic surgery, one could make its own surgical equipment, instead of buying expensive Western equipment. These tools should be of good quality, easily sterilisable, usable in a good surgical technique, made out of materials that are almost everywhere available and, of course, they should not be too difficult to make.

This booklet will try to give ideas about the manufacturing and maintenance of such tools.

The techniques described are not the only ways to make the tools; while working one might find other, better or easier ways to manufacture them.

1 Instruments from a paperclip and stainless steel wire

1.1 Making an eye-speculum from a paperclip:

Aim: inspection of the eye.

These paperclip retractors proved to be as feasible as the eyelid retractors of Desmarres.

Materials:

- Paperclips or wire
- Round tipped pliers

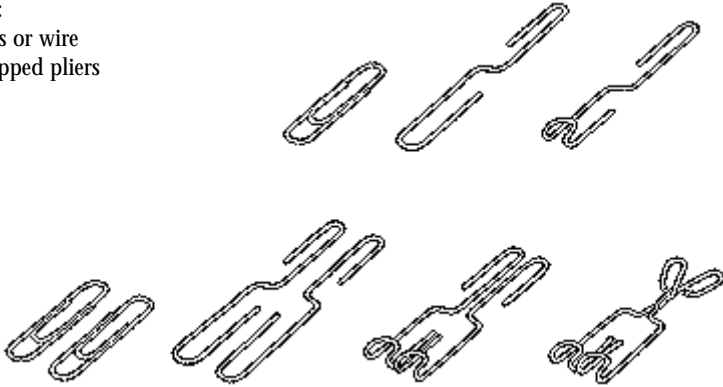

Construction: bend the paperclips according to the drawings, or in any other shape you prefer. Long-nosed pliers facilitate bending.

Before usage the bent part of the retractors can be held in a flame for a few seconds to prevent contamination.

After usage, the retractors are to be cleansed and kept in 70% alcohol or in acetone.

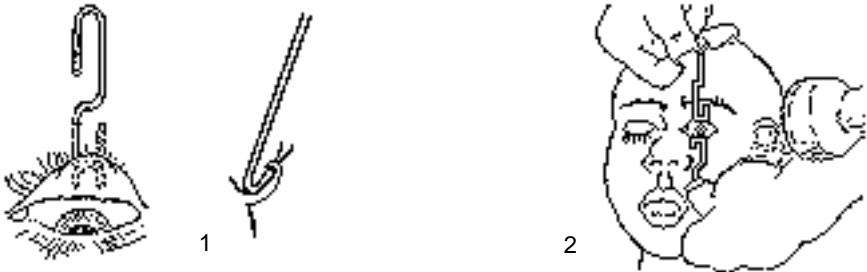

Drawing 1: Double eversion of upper lid for inspection of superior cul de sac.

Drawing 2: Examining a child's eye.

The picture shows one assistant keeping the eye open and immobilizing the child's head at the same time. The battery torch, giving lateral illumination of the eye, clearly reveals corneal and conjunctival abnormalities, especially if the eye is stained with fluoresceine.

Stainless steel wire instruments: wire can be bent with the fingers, fixing the end in a small pipe, or with simple tools such as pliers. The finishing is done by rubbing on rock or by filing down. The elements are fixed by twisting, or by winding them with fragments of copper line, e.g. the wire used in a dynamo. No welding is used. For ophthalmology highly elastic stainless steel wire and lamellae are used. Examples of the results: A: simple lid speculum, small for children, larger for adults of 0.52 mm. gauge wire. A thicker wire of 1.04 mm. results in a stronger spring, for more pronounced eyelid retraction, as needed during enucleation. B: a manual lid retractor is helpful for examination of crying children. With the same kind of handle are made: D: muscle hook, E: lens loop, F: lens expressor, G: a double needle for the fixation of a luxated lens, H: a pigtail probe for the canaliculus reconstruction, and K: long and short forceps for cellulose swabs.

If a round handle is preferred this can be made of a piece of wire of 2.53 mm., split at the end where a piece of thin wire of 0.52 mm. was fixed in order to obtain an L, iris spatula. With the same idea, fixing a flat piece of steel, an M, corneal knife is made.

For lacrimal dilators (2.53 mm.wire)and probes (1.04mm. and 0.52 mm. wire) the extremities of the wire are tapered. Rings of Flieringa of different sizes and a foreign body locator (N) are easy to make. For the latter a ring of 12 mm. diameter, with an indicator perpendicular to its surface, is made which is fixed near the limbus with two sutures during X-ray examination of the orbit.

Using flat stainless steel lamellae of 0.52 * 3.52 mm. O, conjunctival retractors of different sizes and shapes, used during retinal detachment surgery, P, serrefine clamps, Q, a towel clip, and R, a measuring rod are made.

The wire can also form a 'cage' around a Graefe knife, to protect it during sterilization and transportation. (K. Maertens, E.A.J.O./vol 7, no 1 nov/86).

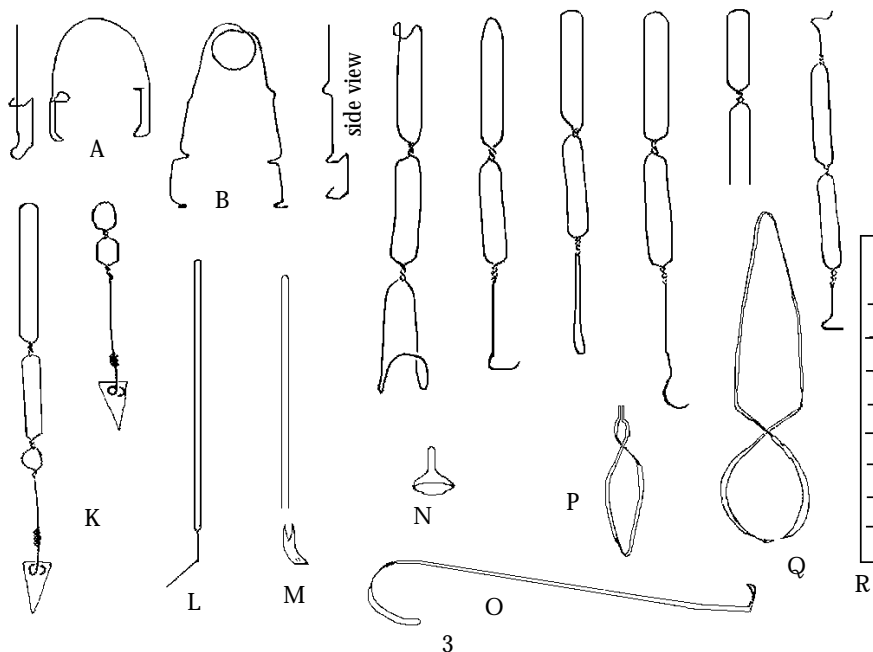

2 Tonometers

Idea by J. G. F. Worst

A screening tonometer for intra-ocular pressure measurement.

You can convert a disposable 2 cc syringe into a gravity activated tonometer.

Manufacturing:

- Take a 2 cc disposable syringe with calibration.
- Make a hole in the end of the plunger.
- Put a disposable needle through this hole. Bend the needle.

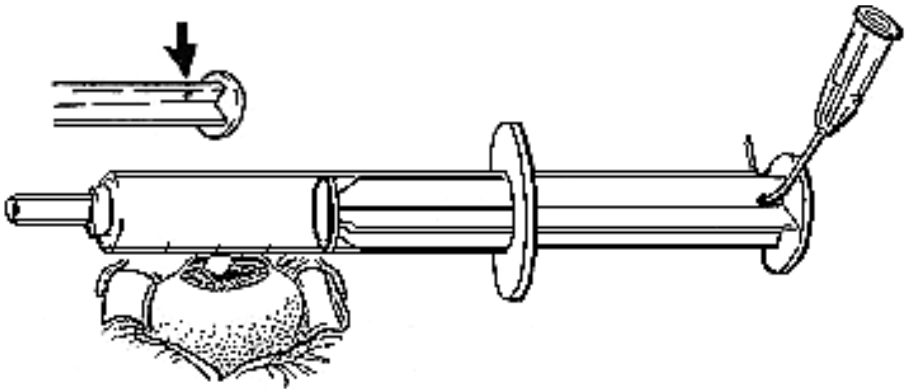

- Fill the syringe with 2 cc. water or saline.

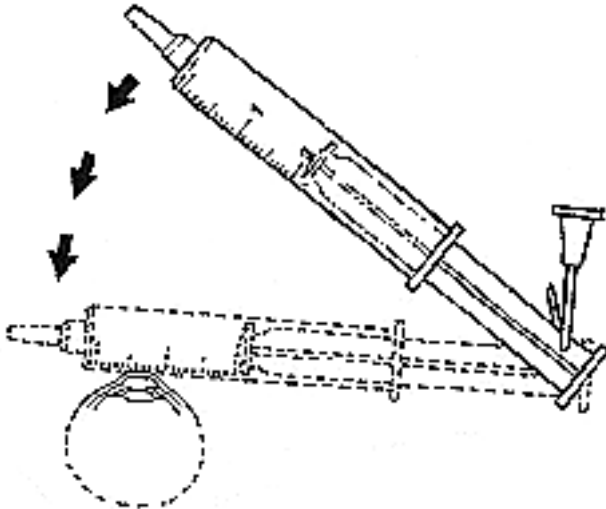

- When held at the needle cone, the needle now functions as a balance.

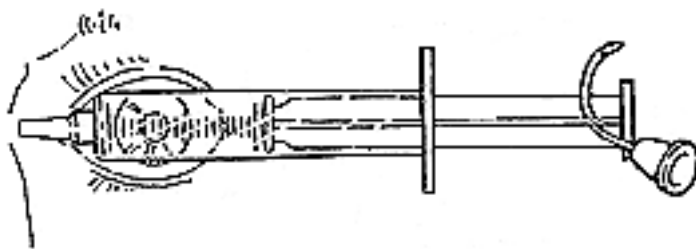

It is essential that the barrel is made of a sufficiently clear plastic to permit viewing of the calibration through the water-filled barrel.

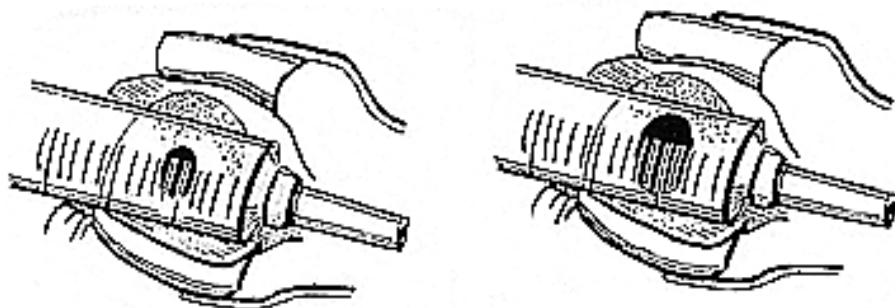

How to use it:

- Put a drop of anaesthetics on the cornea of the recumbent patient. Wait until the anaesthetics are activated.
- Bring the syringe into contact with the anaesthetized cornea of the patient.
- Look through the barrel to estimate the size of the applanated area.

The applanated area is distinctly visible because of the magnifying effect of the water-filled syringe-barrel.

Calibration can be done by comparison with other measurements, e.g. with a Schiotz tonometer.

- Roughly
- 2 lines = about 30 mm Hg
 - 3 lines = about 25 mm Hg
 - 3.5 lines = about 20 mm Hg
 - 4 lines = about 15 mm Hg

For each type of syringe barrel a corresponding calibration is required. The readings are accurate and reproducible provided the syringe is filled with the same quantity of fluid, each time, and provided the same area of the barrel is used for the measurement.

3 Diagnostic tools

Mini phoropter. The lenses in the turning table of a direct ophthalmoscope may be used as a mini-phoropter for example field work or in any place where a trial-lens set has not been taken along. It might be interesting to try to quantify the pin hole effect of the small lenses. The lenses may, be used also to determine the value of spherical lenses in glasses by neutralization. While looking into the distance through the glasses and the + 20 lens in the hole of the direct ophthalmoscope the disk is turned back until a clear image is obtained. At this point the lens in the glasses is neutralized.

Holger Tubessing, Ngaoundere, Cameroon

Indirect ophthalmoscope:

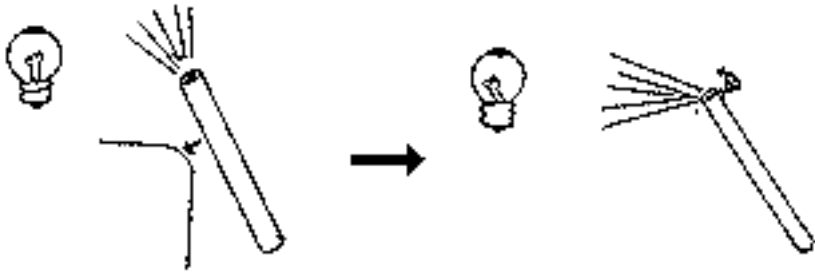

If you give a hard knock with a pen-light on the edge of a table the metal support of the filament in the bulb will deflect. This produces a decentration of the light, sufficiently far of the centre to permit the use of the penlight as a hammerlamp.

To improve your chance of getting a good result you may give the knock at the side where the filament is already decentrated; let the light shine on white paper and mark the side to which it is decentrated before knocking.

Ophthalmoscope.

materials used:

- black PVC water pipe, 2 cm in diameter,
- a torch
- aluminium foil
- glue



Procedure:



- part of the pipe is cut off and flattened after heating to obtain material out of which discs are cut:
- one disc is cut to replace the glass in the torch. In the centre of this disc a hole is cut which corresponds to the diameter of the pipe (2 cm).
- the pipe is cut obliquely (45 degrees) at 15 cm.
- an other ovaldisc is cut which can close the oblique end.
- in this oval disc a small hole is made for observation.
- a hole is made in the pipe, opposite the observation hole.
- the oval disc and the interior of the pipe, except the part around the hole, are covered with aluminium foil for maximal reflection.
(reflection around the hole in the pipe would shine into the observer's eye-avoid this).
- the oval disc is glued on the pipe, the other end of the pipe is glued into the hole in the round disc on the torch.

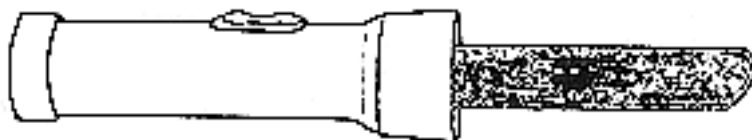

Although this ophthalmoscope does not give an uniformly illuminated spot it offers the opportunity to study the optic disc in a dark room. As refractive errors are rare in Africa the lack of a correcting system is not serious there (in other places one can use the appropriate lens, held in front of the eye).

Summary of an article by K. Maertens, in *Tropical Doctor*, july '85,pp 141-142.

Ophthalmoscope with a pen torch

With a pen torch held fixed just above or below the fixating eye and an aspheric +20 or +28 ophthalmoscopy lens, held in the usual position, a good image of the fundus posterior to the equator can be obtained.

KR Bishai, *Brit. J. of Ophthalmol.* 1989, 73, 235-236

Note any torch will do, if not too large.

E-CHART AND TESTING VISUAL ACUITY.

E-chart.

The chart can be painted on a piece of wood, on a wall, or it can be stitched on cloth. For any method one E of each size is cut out of cardboard, to be used as a stencil (see drawing 4). These stencils are copied, pointing in different directions, one or more rows for each size. The number indicating the visual acuity needed to see this row is written at the end of each row, and on the stencils for reference for later use. Numbers are marked on the side, 0.1, 0.3, 0.7, i.e. patients distance divided by the distance at which a healthy eye can see this size of E.

Cloth 'chart'

Use a good quality (synthetic) black fabric for the E's, or they will fade out too soon. Wash the fabric before use, to shrink it.

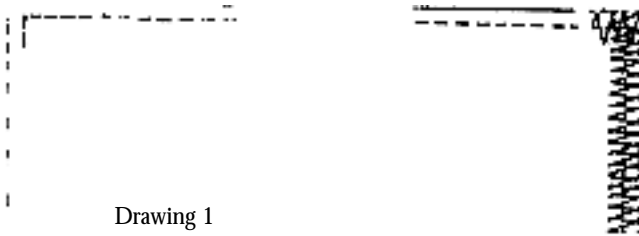

Straight line is stitched first (machine-backstitch), about 1-2 mm from the edge of the E. The E's can be cut out with a seam before stitching, the exact shape being cut after the first stitching is finished.

It is easiest however, though less economic, to pin the black fabric onto the white fabric and to draw the E's on the back (straight grain of fabric!).

In this case the stitches are made on the back, 2 mm inside the border of each E.

Only after stitching the exact shape of each E is cut out by cutting at 2 mm outside the stitches. Each E is finished by a zig-zag stitch or buttonhole (3-4 mm wide) over the row of back-stitches, touching the edge of the E's.

Of every size several E's are made, pointing in different directions.

The numbers can be embroidered or stitched (small backstitch).

A plastic chart.

This is made out of white plastic and black adhesive plastic. It is washable, but the plastic will become yellow if exposed to the sun too much, so cover it when not in use.

Testing visual acuity.

The chart is placed in a bright place or under constant illumination at a distance of 5 meters from the patient. Both chart and patient must not stand in the sun but in the shade.

The examiner can be helped by an assistant who explains how the patient has to cover the eye which is not examined with a shield. Make a habit of examining the right eye first.

The examiner points at each symbol without touching it or covering it and asks the patient to indicate, with the special device or his hand, in which direction the E points.



Drawing 2

5 m.



The examiner records for each eye separately the row with the highest number the patient has managed to indicate correctly, without making a mistake.

Thus, if the patient has correctly imitated line 0.1 but no more with the right eye, and line 0.7 but no more with the left eye, then the examiner will record R 0.1 and L 0.7.



Drawing 3

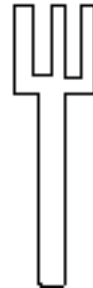

The eye can also be tested with a card with one or several small holes (2 mm) in it as well: if results improve considerably an anomaly of refraction may be the cause of low vision and spectacles may have to be prescribed.

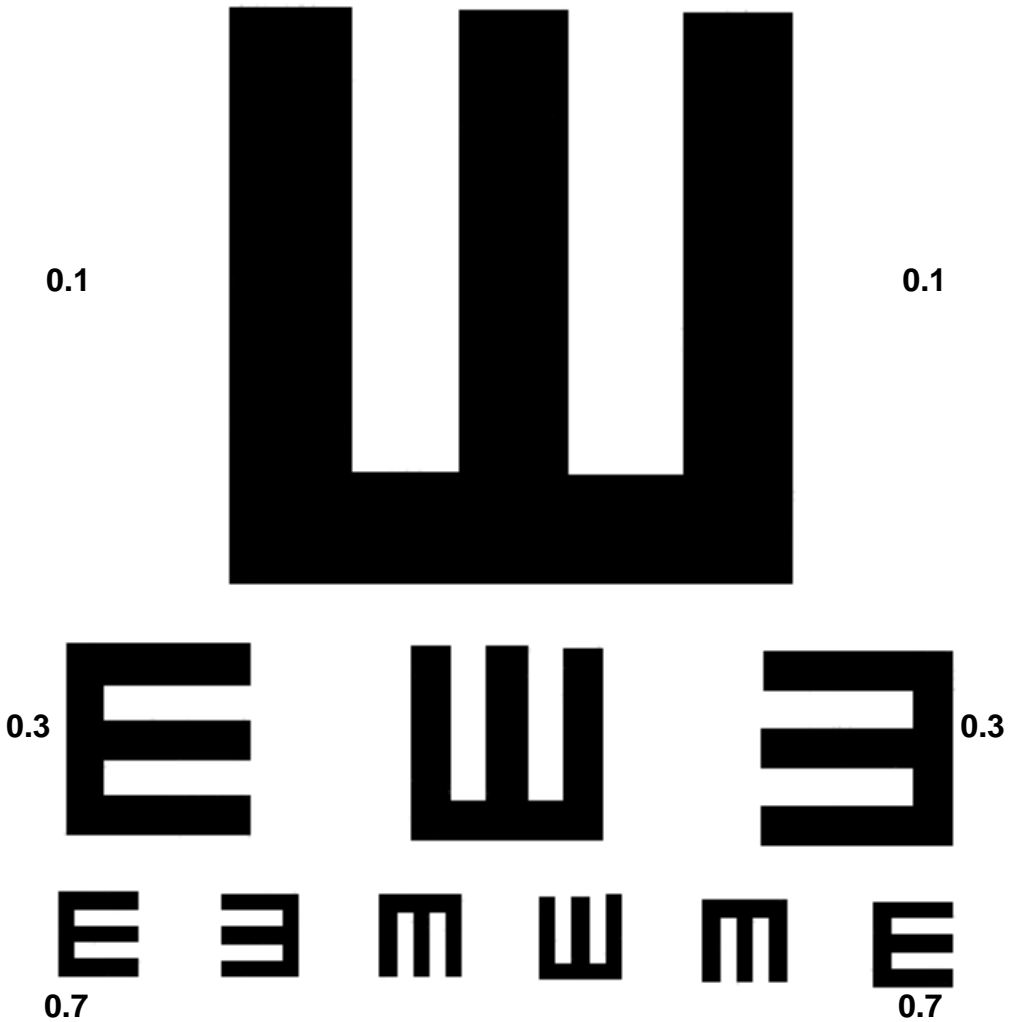

Drawing 4

These are the true sizes of the symbols with the patient at 5 meter distance.
 In order to minimize the chances of memorizing and deception, the screen should be turned frequently to any one of the four possible positions and the patient asked to read horizontal or vertical rows as appropriate.

4 Slitlamps

A. Hand-held slitlamp according to Ensink

Technical data:

Weight	450 gr.
Dimensions	6*9*22cm.
Slit-dimensions	6.5*0.15 mm. fixed
Slit-angle	0-40 degrees
Batteries	3 built in NiHycells, 1,2V each, 1200mAh
Lightbulb	Heine XHL 3.5Volt (type X-02.88.048)
Charging-time	12-14 hours when empty. Full charge will supply power for more than one hour

Optics (all coated glass)

Magnification	10
Field	13.5 mm.
Vertex distance	13 mm.
Exit-pupil	2.3 mm.

Eyepieces cannot be adjusted.

Easy adjustment for interpupillary distance.

Price 1996-1997: complete 2188 US Dollar

Ensink-Instruments 🍏

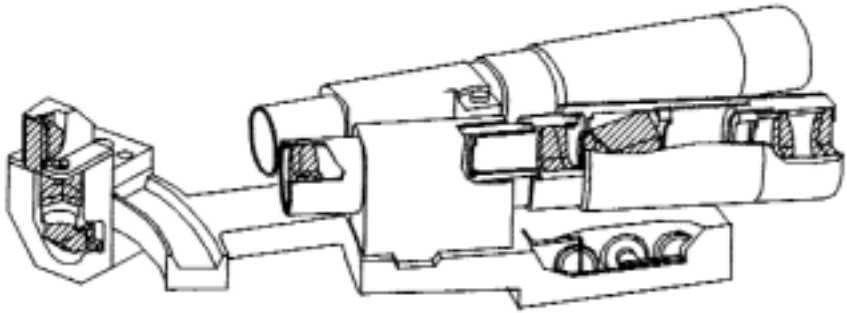

B. New Scan Optics Hand-held Slitlamp

Model SO-801 Slitlamp: similar in size as the direct ophthalmoscope. Rechargeable battery handle.

Price 1296 US Dollar

Scan Optics 🍏

Prevention of fungi in optical parts of slitlamp

Doctor E. Hertz (Cameroon): Prevention of fungi in optical parts of slitlamp in humid climates:

Put a wooden box over slitlamp, mounted with an electrical bulb: the heat generated by the bulb, lowers the humidity inside the box.

Ensure sufficient ventilation.

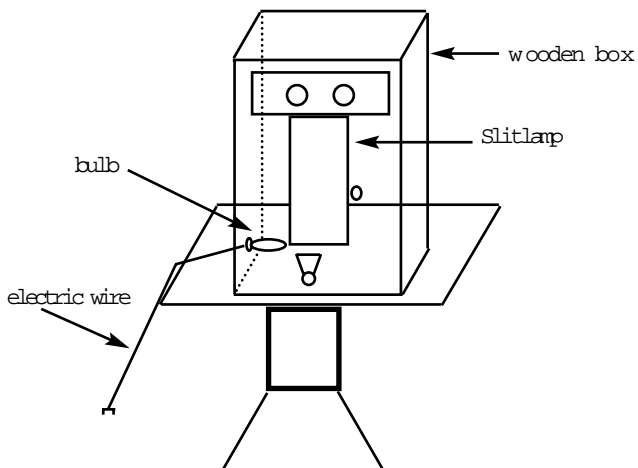

5 Campimeter

The Multifixation Campimeter

This visual field test has been designed to allow examination of the visual field when more sophisticated methods are impractical. It uses the patient's eye movements to position a fixed test stimulus at known points in the visual field, using a series of fixation targets to alter the direction of gaze in a precise manner.

Litt. The detection of glaucomatous visual field defects by Oculo-kinetic Perimetry:

Which points are best for screening?

B. E. Damato a.o. Eye (1989) 3, 727-731

address:

Dr. Bertil E. Damato, PhD, FRCS, FCOphth

St. Paul's Eye Unit

Royal Liverpool University Hospital

Prescot Street

Liverpool

L7 8XP

United Kingdom

Tel: 44 (0)51 706 2000

Fax: 44 (0)51 706 5806

6 Manufacturing Ophthalmic Surgical Knives

By: J.G.F. Worst

Drawings: Wim Velt

Taken from: 'The Ophthalmic Toolbox',

a Jan Worst Research Group publication 

6.1 Equipment:

- 1.0 cc. tuberculin syringe
- 16 Gauge injection needle
- 0.5 mm. steel wire
- doorhinge blade breaker and screw (prefabricated; see 6.2)
- non-breakable razor blades
- a pair of scissors
- a triangular file
- a needleholder
- a pair of round tipped pliers

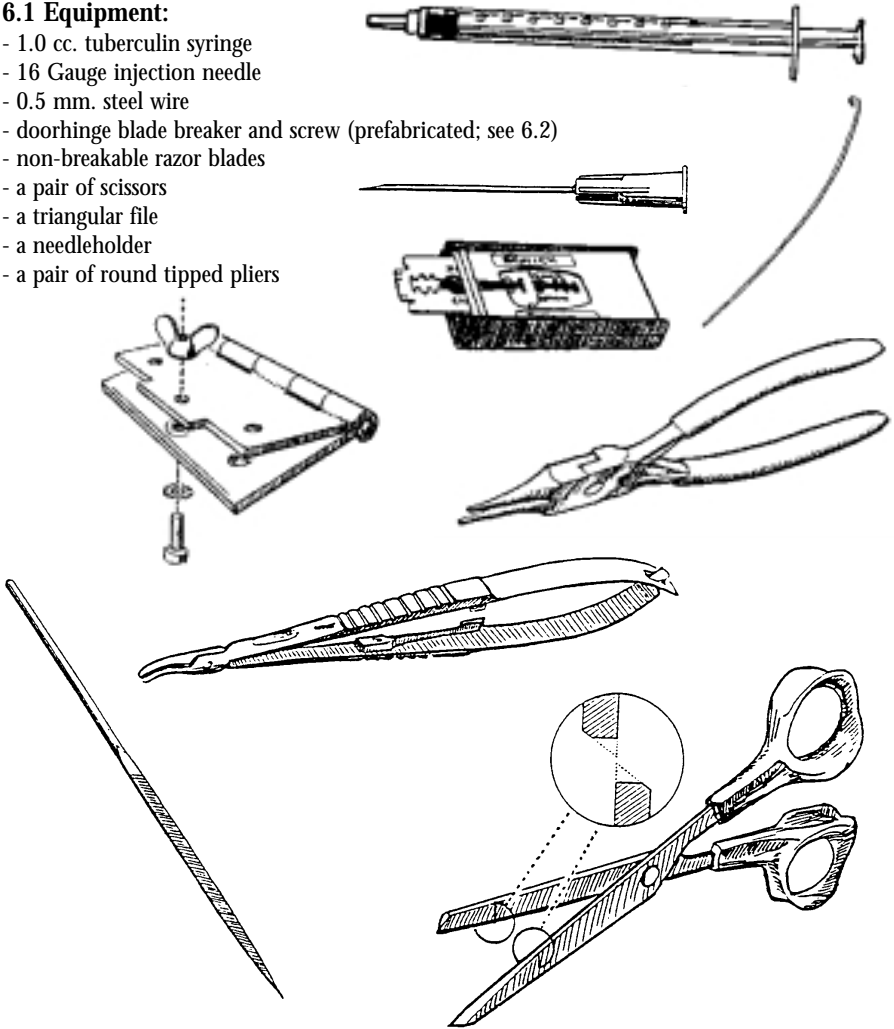

6.2 Doorhinge blade breaker:

- Sawing two notches in one side of the doorhinge.
- Make both sides of equal length and remove burr.
- Scratch a line at exactly 1.6 mm. distance from edge of hinge.

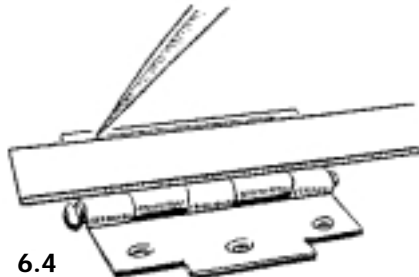
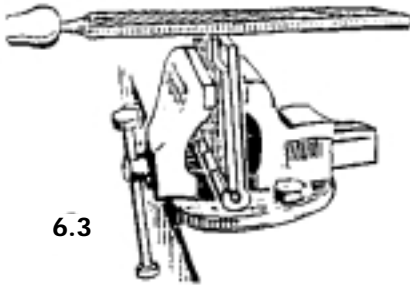
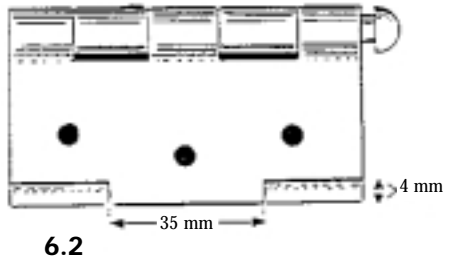
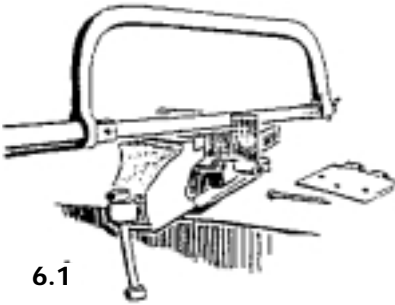

6.3 Breaking the razor blade to form a knife:

- Position the razorblade between hinge with the edge of the blade aligned to the scratch (fig. 6.5).

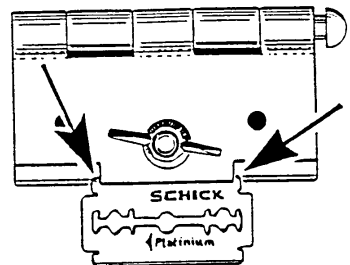
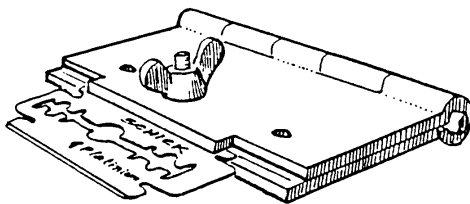

- Break the blade on hinge against table surface, with pushing and pulling movements (fig. 6.6)

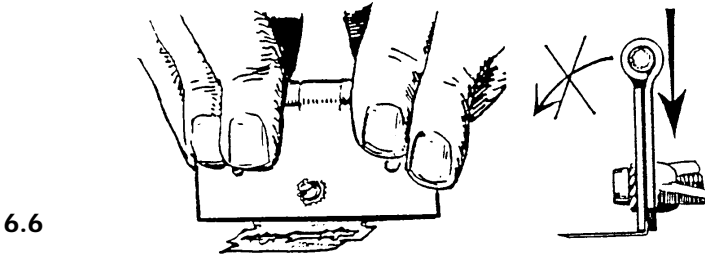

- result: blade edge of 1.6 mm. (fig. 6.7).

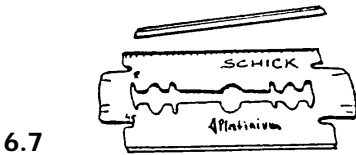

6.4 Preparation of the bladeholder:

- File a notch on the 16 Gauge needle, with a triangular file (fig. 6.8).

- Break off the tip of the needle (fig. 6.9).

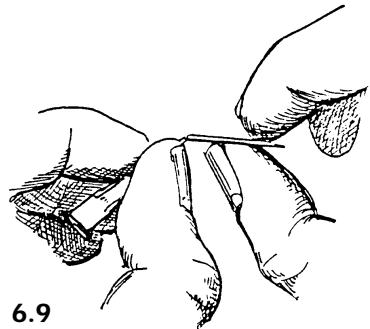
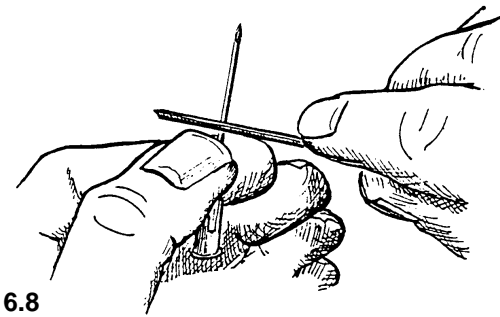

- Blunting the anterior part of the broken off needle (fig. 6.10).

- Reaming the inside of the needle. The tip of the triangular file is used for this purpose (fig. 6.11).

- Flattening the end of the needle (using the pair of flat tipped pliers), with 0.5 mm. wire inside cannula (fig. 6.12).

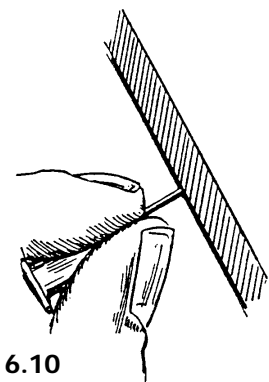

6.10

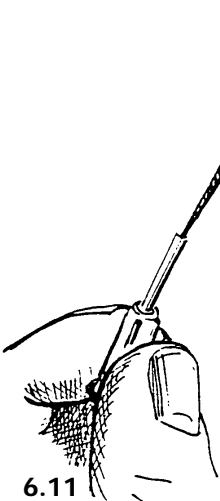

6.11

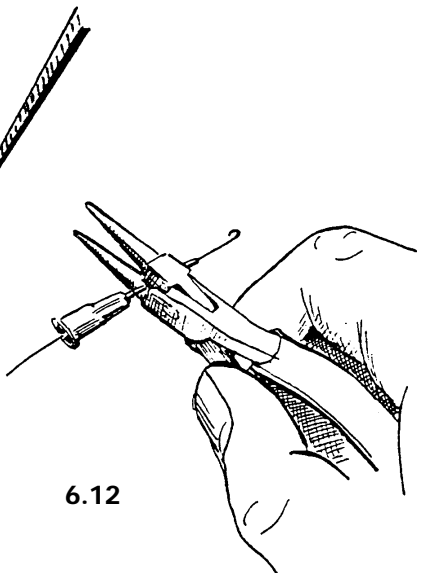

6.12

6.5 Fixation of the blade sliver:

- Push the blade into the needle. Keep the sharp edge directed away from yourself to protect the sharp edge (fig. 6.13).

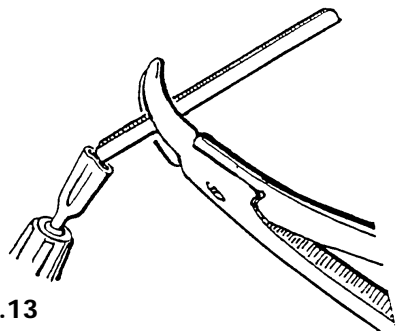

6.13

- The blade is pushed deep into the needle and will fixate itself automatically. The blade should be held at a short distance from the needle when pushing it in, otherwise it will bend.
- Cutting off the blade with high quality scissors (the cutting edges off the scissor should be about 90°; see 'Chapter 24, Sharpening of scissors). Start cutting from the sharp edge of the razorblade, otherwise the tip will bend.
- *Result:* The razor blade is stuck in the needle, and a syringe can be used as a handle. If water is injected in the syringe, the system will function as an irrigating knife (Worst) (fig. 6.16).
- Use the cut-off needle cover for protection of the blade (e.g. during sterilisation or storage) (fig. 6.17).

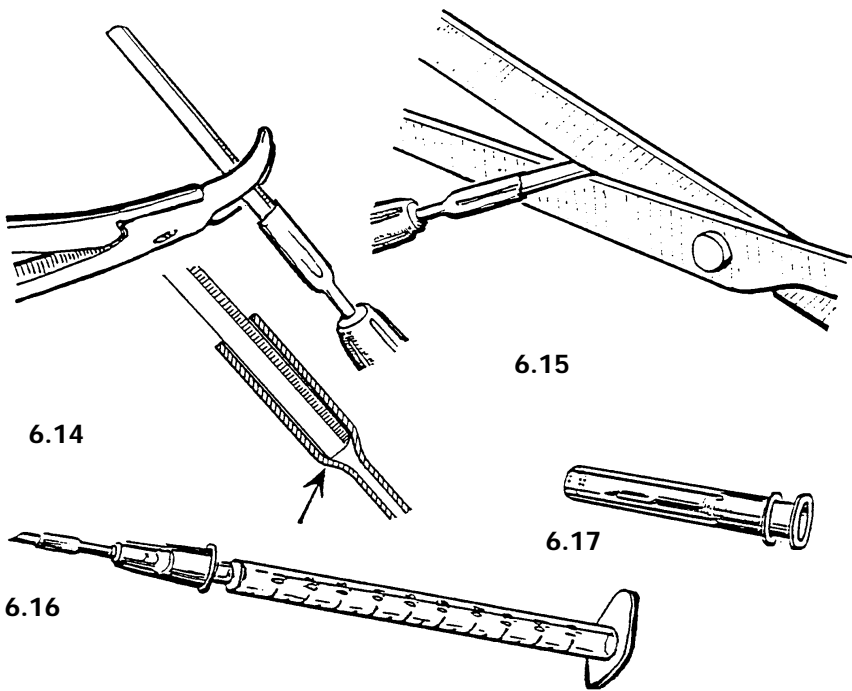

6.6 If the blade becomes blunt:
- Cut a second time
- Remove and insert a new blade.

6.7 Preparation of an irrigating handle:

- Cut off the back of a 1 cc. tuberculin syringe using heavy scissors.
- Take an 18 Gauge needle; break the needle halfway (for technique see 6.5).
- Cut off half of the needle cone and heat the remaining part to plastify. Take care not to burn the cone. *Heat in the hot air, not in the flame!*
- Put the melted cone in the back of the syringe, and let them harden together.
- A silicone tube of 1.2 mm. inner diameter and 2.5 mm. outer diameter can be used to connect the irrigating handle to a syringe to be operated by the assistant.

Literature:

J.G.F Worst, L.I. Los: The irrigating knife: an ultrasharp surgical blade with irrigating system. *Ophthalmic Surgery* (1990): 21: 654-656.

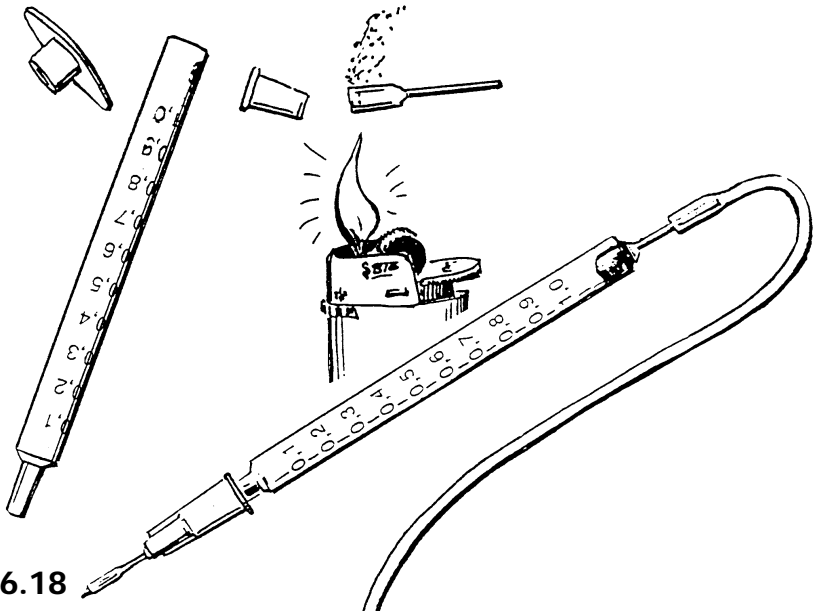

6.18

7 Microsurgical Needle and Suture Manufacturing

By: J.G.F. Worst; N. Aponno

Drawings: Wim Velt

Taken from: 'The Ophthalmic Toolbox',

a Jan Worst Research Group publication 🍏

The most important part of ophthalmic surgery (and surgery in general) is good wound closure. Disposable corneo-scleral needles are prohibitively expensive. But today corneo-scleral needles with an eye have also become a budgetary problem.

This chapter describes a do-it-yourself method to needle manufacturing under less privileged conditions than in ophthalmic hospitals in America and Europe.

7.1 Equipment:

- a pair of prefabricated needle bending pliers 🍏 (pliers)
- a pair of round tipped pliers
- a needle holder
- a 30 Gauge injection needle 🍏 (needle)
- a bobbin with 50 mu soft stainless steel thread (or any other suturing material) 🍏 (nylon 8-0)

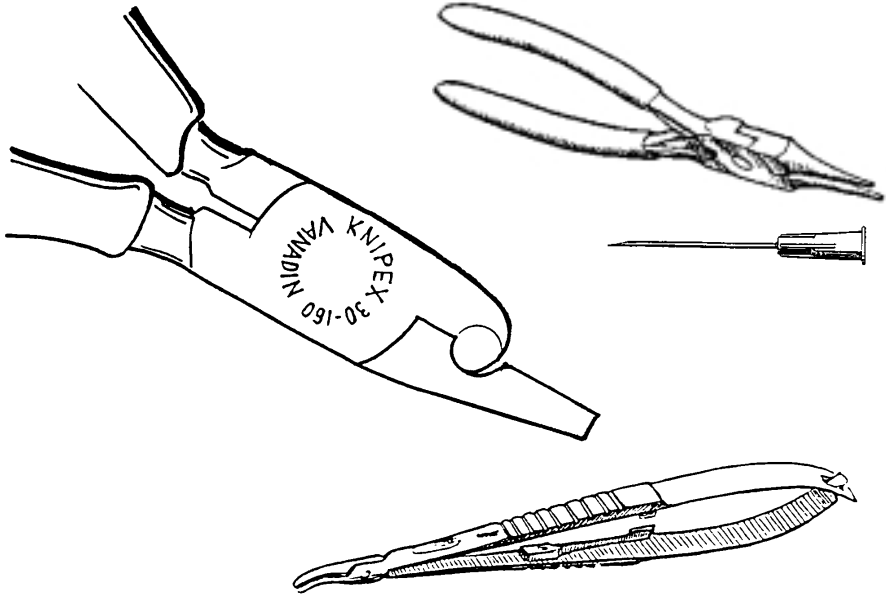

7.2 Procedure:

- Straighten \pm 25 cm. soft stainless steel (or other) suture from the bobbin with the needleholder. Cut the straightened part of the suture of the bobbin.

- Insert the suture into the tip of the needle.

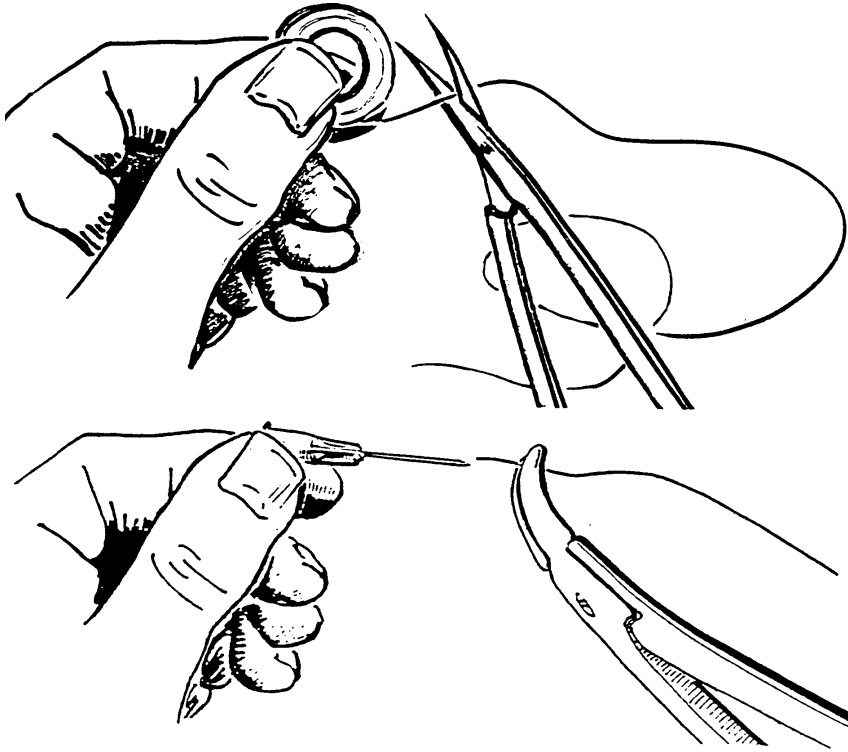

- Pass the straightened suture through the lumen of the needle, until the end disappears just inside the tip. When Virgin silk is used leave some silk sticking out of the needle, since virgin silk tends to slip out of the needle during the procedure. The silk, which is still sticking out can be broken off afterwards, by pulling the silk backwards over the needle. The silk will be cut off by the sharp edge at the end of the bevel.

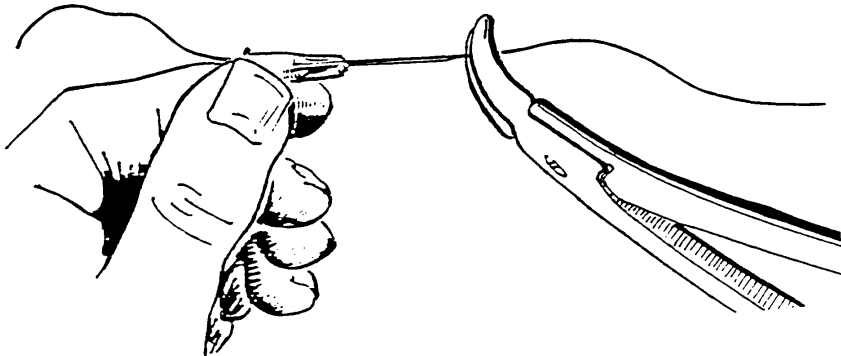

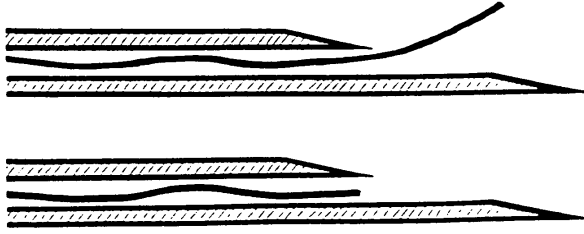

- The 30 g needle is placed between the jaws of the needle bending pliers. The bevel of the needle tip should face the concave female side of the jaw.



- The needle is compressed with the pliers. During compression, some counterpressure must be exerted on the needle in order to prevent it from slipping. Note that the rear part of the needle remains open.

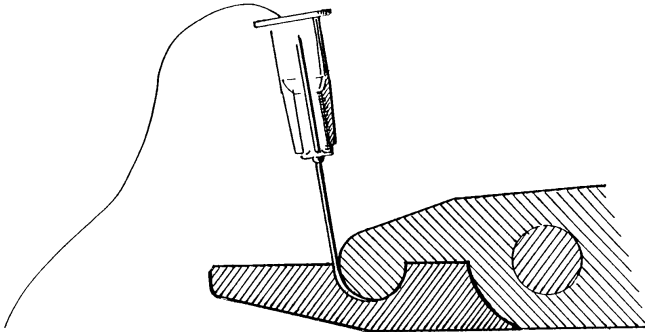

- After bending, the needle is removed carefully from the pliers. *Note:* Take care that the tip of the needle does not touch the pliers, as this will inevitably blunt it.

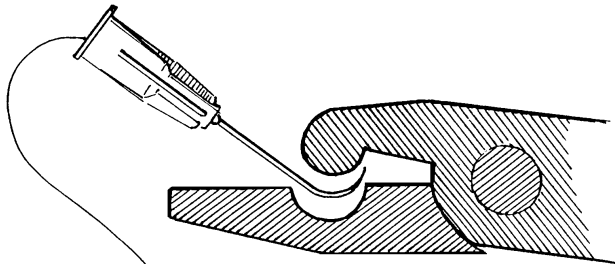

- The needle is broken off by multiple to-and-fro bending movements over a small angle, while grasping it with a needleholder.

Note: Do not bend over a large angle, otherwise a sharp burr will be formed which cuts off virgin silk sutures!

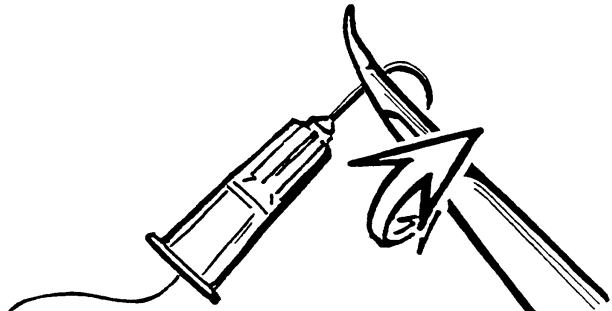

- The broken off cone is slipped backwards over the suture.

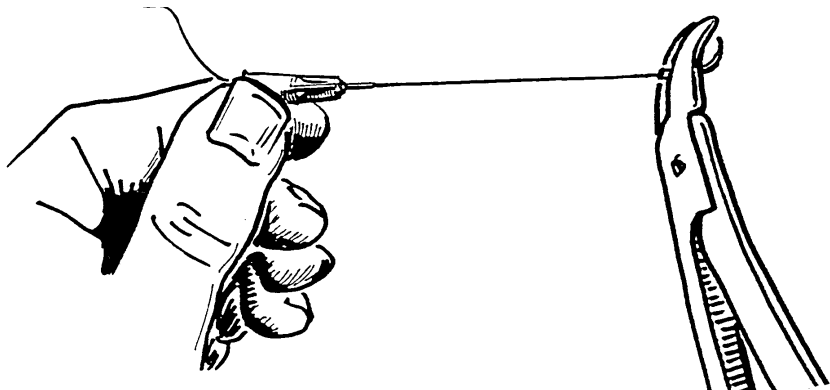

- One may now break off the needle a second time. This results in a 'identification tag'.

- Compress the tag with the round tipped pliers.

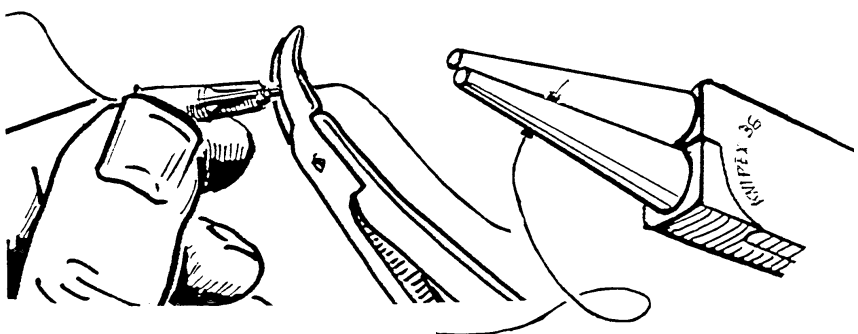

- In case of a stainless steel suture: stretch it before use, to remove any kinks.

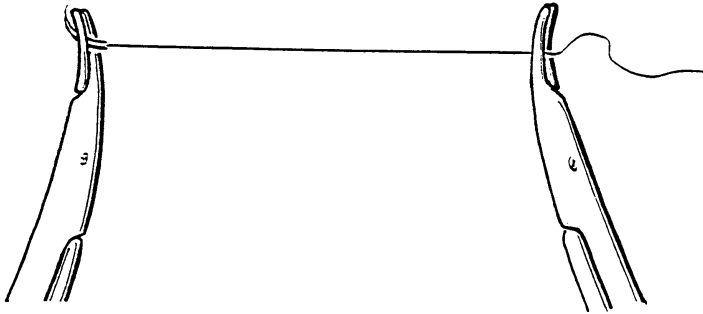

7.3 Sterilisation:

- The needles can be sterilised by putting them in an autoclave or by boiling them.
- Packing the needle: use a piece of paper of 2.5 by 6 cm., fold it to 2.5 by 3 cm. Make small incisions on both the short sides and on one long side of the paper. Put the needle inside the paper and fold the suture through the incisions on the short sides. The end of the suture is folded through the incision on the large side, for easy unwinding.

7.4 Suture rack:

Take a 25 cm. wide piece of paper (the length depends on the number of sutures you want to store, 4 cm for each suture) and pleat this with pleats of 2 cm. Fold the 3 cm at the end of the pleats to form pockets.

- Take more than 25 cm length of stainless steel suture, stretch this lightly and put it on the suture rack. The pocket serves as a stop at the rear end.
- Cut the sutures at the other end.
- Sterilize
- For use: support the rack on a folded triangle.

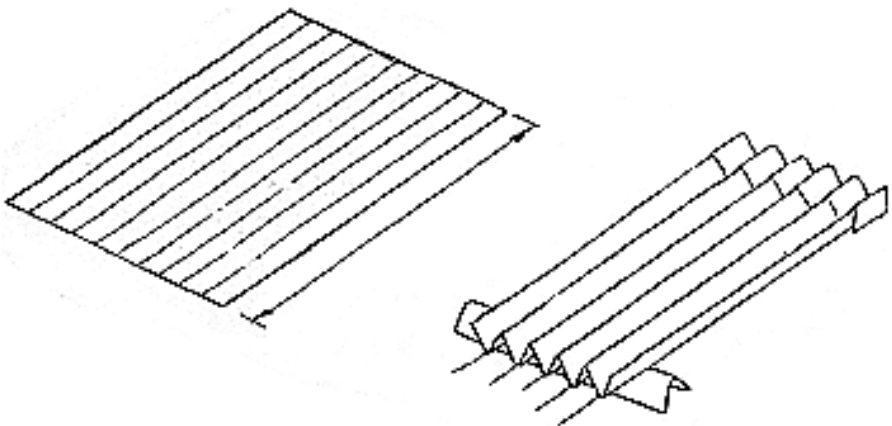

8 Manufacturing an ITIR Cryo extractor

By: J.G.F. Worst

Drawings: Wim Velt

Taken from: 'The Ophthalmic Toolbox',

a Jan Worst Research Group publication

Equipment:

- 0.47 mm. stainless steel capillary (about 100 cm. long)
- a plastic tube (which fits in the spray opening of the can with coolant)
- a can of Freon or other fluid coolant (cryo-fluid)
- a gaslighter
- a needleholder
- a knife
- a 16 G injection needle
- an 1 cc. tuberculin syringe
- soldering equipment

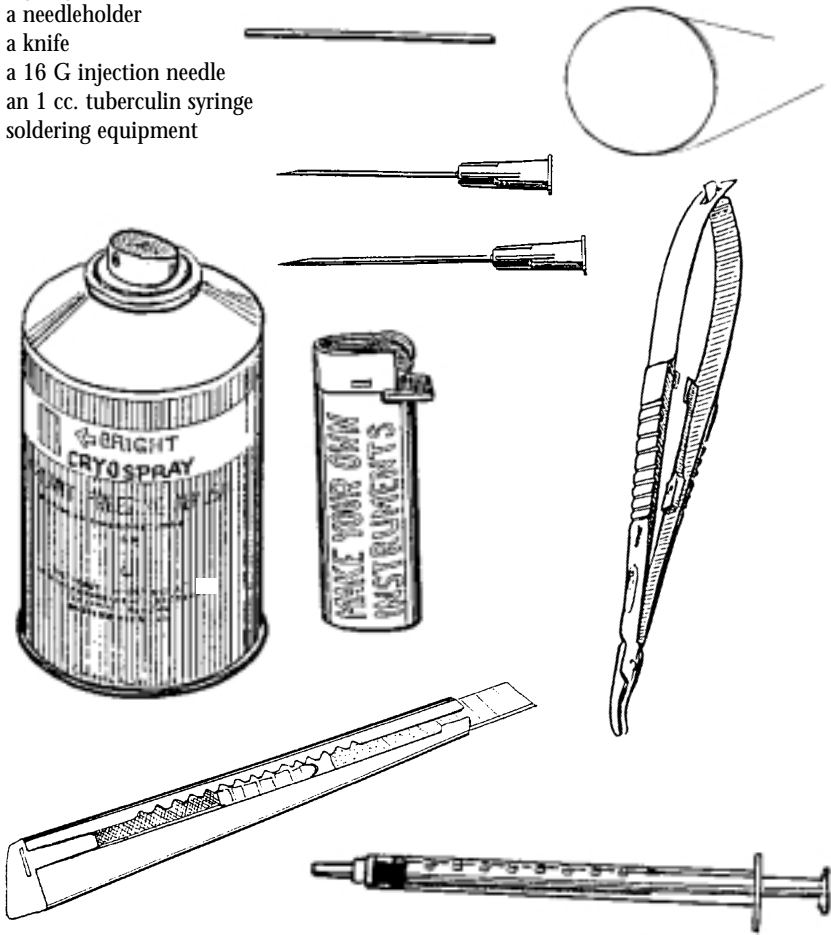

8.1 Preparation of the connecting tube

This part will form the connection between the cryoextractor and the freon can. The metal capillary will be closed inside a plastic tube, in order to let the freon gas flow through the metal capillary.

Procedure:

- Cut the plastic tube to ± 35 mm. (this way the tube can be used for approximately 3 cryo's).

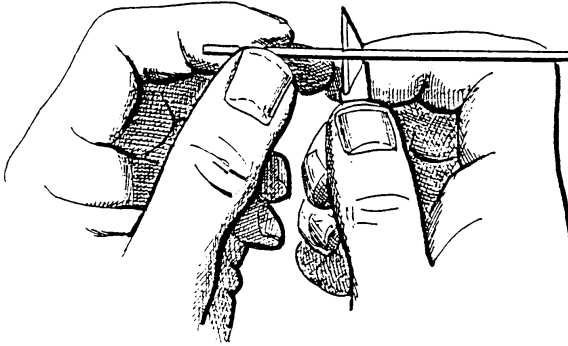

- Break off capillary, to ensure open ended lumen.
Make repeated bending movements over a small angle. The capillary should break off through metal fatigue.

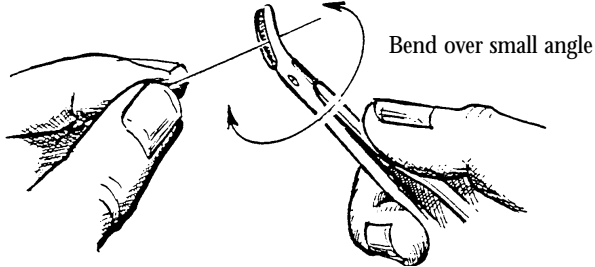

- Measure capillary length, make a bend in capillary (midway on plastic tube) and insert capillary in the plastic tube.

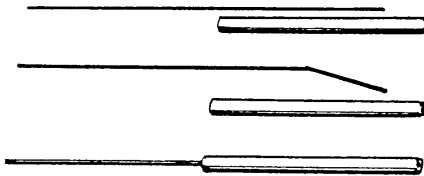

- Heat tube *over* flame. *In the rising hot air and not in the flame!*

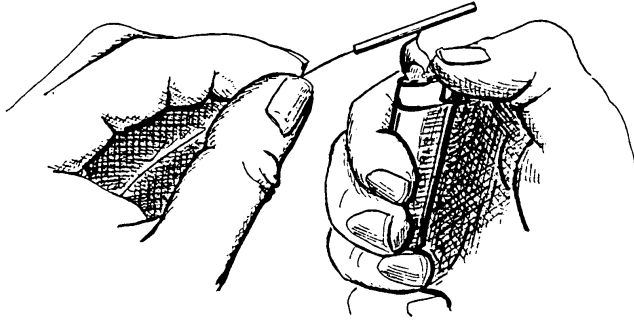

- Twist the heated part of the tube. The plastic is now melted around the metal capillary. This way the gas can only go through the capillary.

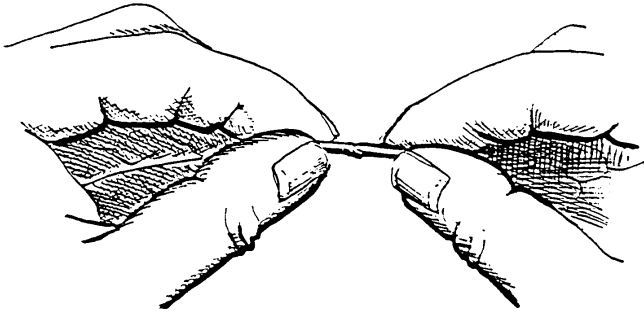

- Test for leaking by activating valve.
Note: cooling of fingertip is sign of leakage.



8.2 Preparation of the handle

A 1 cc. syringe is used as a handpiece of the cryoextractor. The metal capillary has to be fixed inside the syringe, to prevent it from slipping out.

Procedure:

- 3 steps of producing an eyelet on the capillary.

Note: Be careful, avoid compressing the capillary

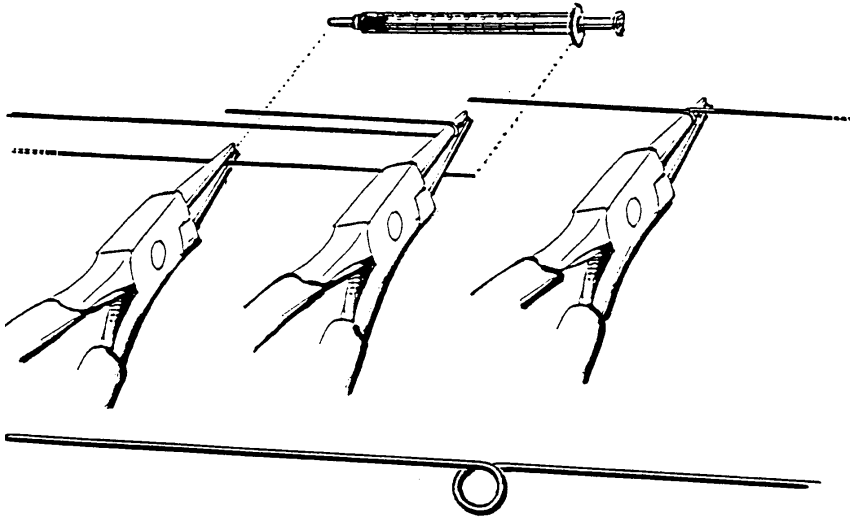

- Remove the rear part of the syringe.
- Insert the metal capillary with eyelet inside the syringe.
- Heat syringe barrel over flame.

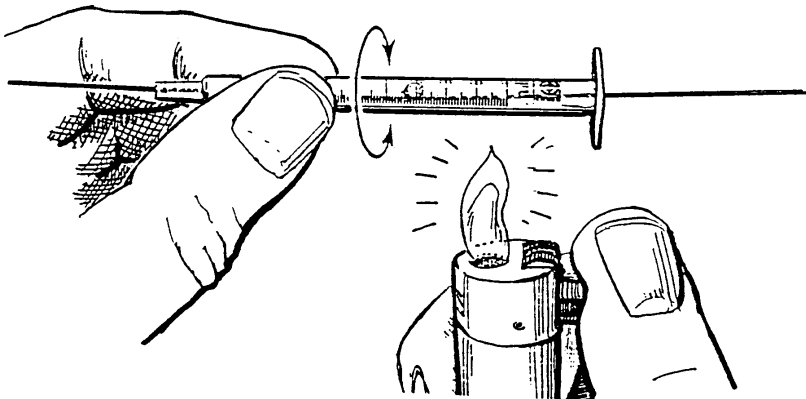

- Twist heated spot until lumen closes.
Keep the eyelet free from twisted spot.

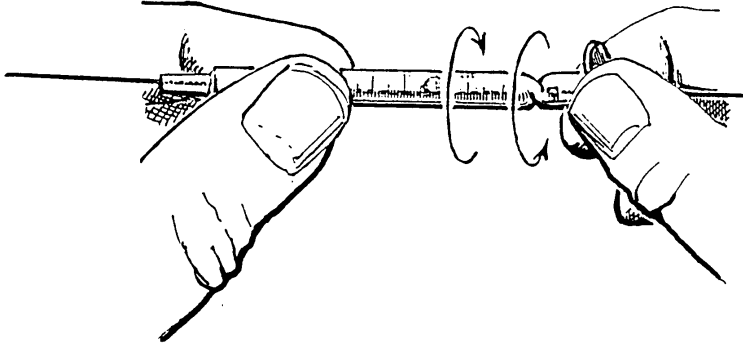

- Perforate twisted area, with needle, to create free communication. This is very important, failing to do so will lead to an increasing pressure inside the cryoextractor.

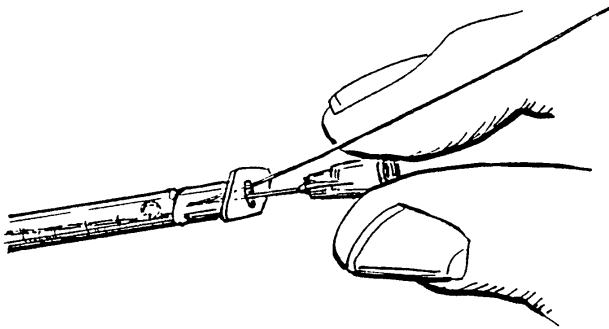

8.3 Preparing the tip of the cryoextractor

For the tip of the cryoextractor a 16 or 18 Gauge injectionneedle is used, which will be closed using a soldering procedure.

- A. Filing a notch on the 16 Gauge needle, with a triangular file.
- B. Breaking off the tip of the needle.

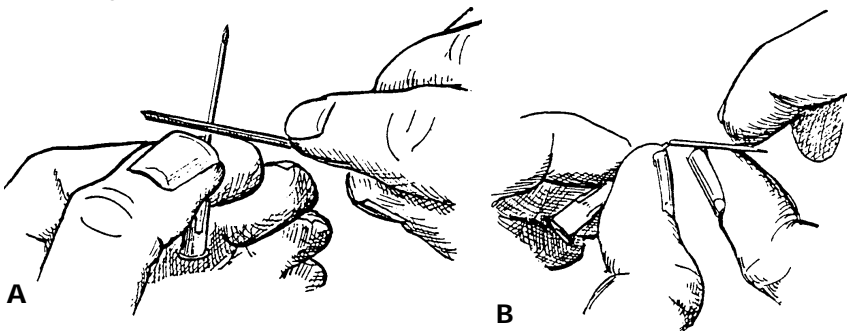

C. Blunting the anterior part of the broken off needle.

D. Reaming the inside of the needle. The tip of the triangular file is used for this purpose.

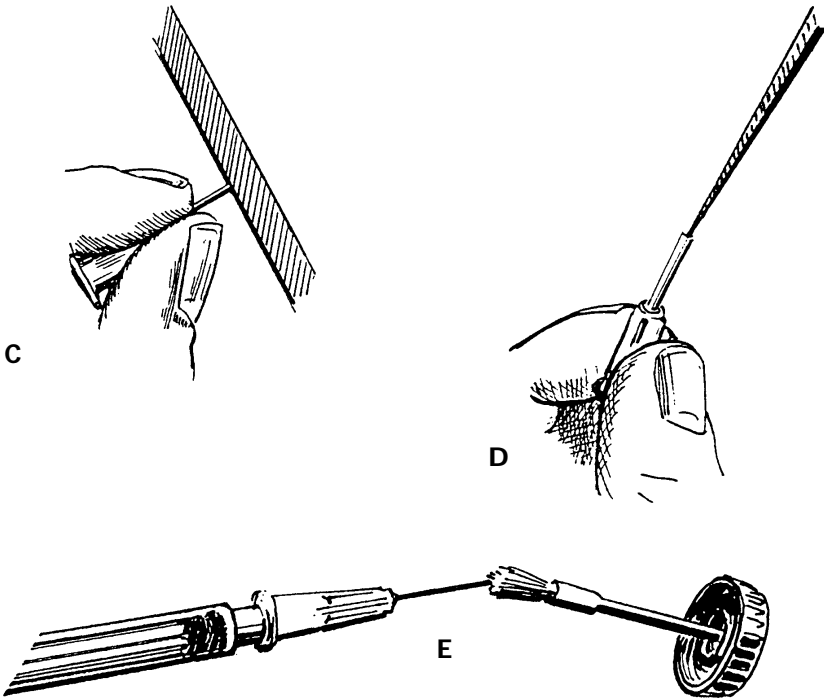

E. Moisten the tip of the needle with a small drop of soldering flux. Do not overfill the canula of the needle with the soldering flux. One should avoid the capillary action. This can be done by closing off the cone of the 16 or 18 G. needle. Put a 1 cc. syringe on the needle, the plunger should be on 0. There should be no air chamber present in the syringe as the flux will tend to reflux inside the needle, which will solder a large part of the lumen.



F. Heating the tip of the cryo extractor with a soldering iron. One should aim to put the smallest drop of soldering tin on the tip of the needle.

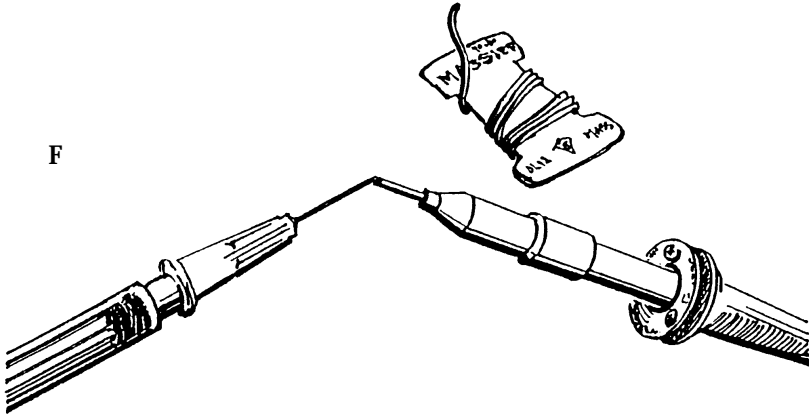

G. Trimming the tip of the cryo extractor with a honing stone (or a triangular file/sandpaper and a rough cloth).

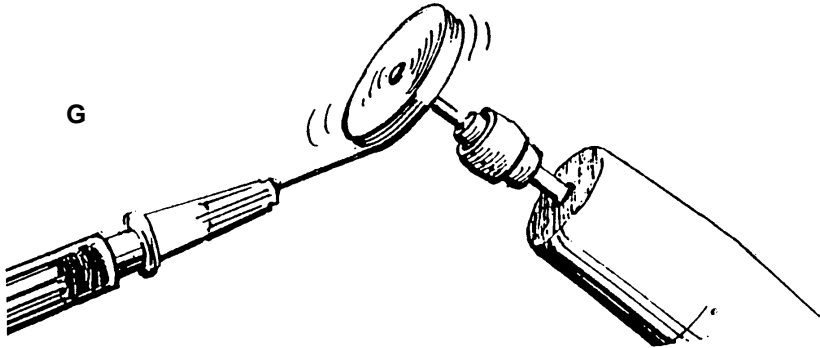

H. The result of the manufacturing-procedure. Only a small amount of soldering tin should fill the tip of the cryo extractor. One may examine the free length.

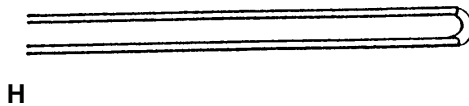

- I. Accurate measurement of tip length of capillary.
Break off by repeated bending (avoid closing lumen).

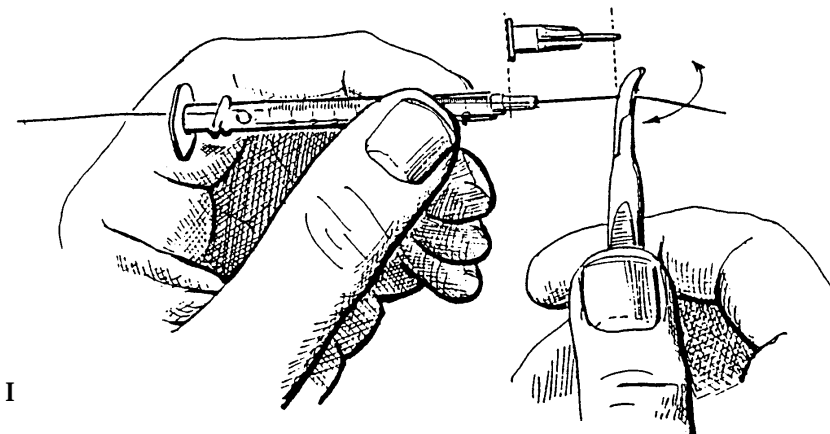

- J. The final result. Due to the very thin lumen of this cryoextractor, a very small amount of freon gas will be used.

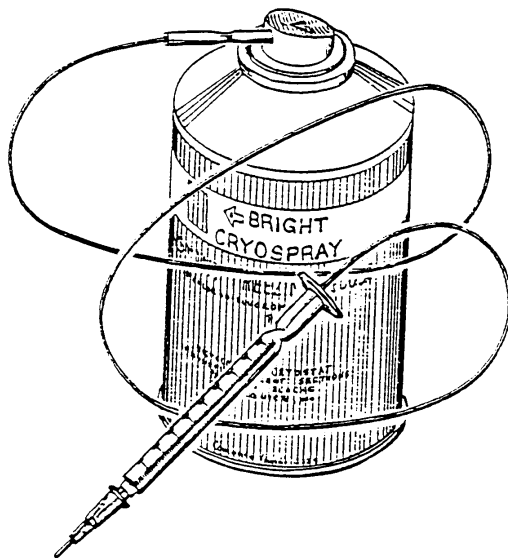

9 Making a cauter

A pin, clamped in an artery or mosquito-forceps, heated in a spirit-flame, provides the required amount of heat for a cauter. Excellent reach without charring the tissues.

A muscle-hook or a probe can be used as well.

A small metal ball, or copper wire wound around the shaft, at some distance from the tip, stores heat and prevents overheating the tip. (it serves as a heat-sink).

10 Surgical loupe

Materials needed:

- two + 6 D magnifying glasses, e.g. from toy binoculars (children's fieldglasses).
- spectacle frame, e.g. from cheap sunglasses.
- plastic box, e.g. Kodak slide box.
- rod iron or solid metal wire.
- sharp knife, drill, pliers and glue.

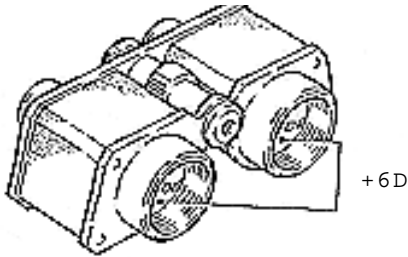

Construction:

- cut the box with a sharp knife (or with a cauter) along the dotted lines as indicated in the drawing.
- make an opening in the front where the glasses will be fixed.
- drill 2 holes near the two rectangular 'temporal' corners (see arrow).
- put steel wire or rod-iron through the holes and bend on both sides over 90 degrees.

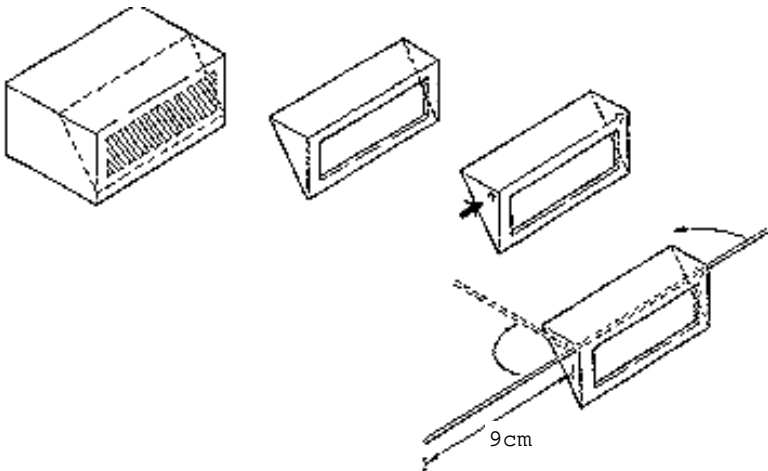

- fix the lenses on the box frame with glue.
- remove the sunglasses from the frame and drill two holes in the outer-upper parts of the frame.
- insert the steel wire into the spectacle-frame through the two holes.
- fix the wire (bend or glue) in such a way that the distance between frame and glasses is about 8 cm. (try first, to adjust to your demands and your glasses).

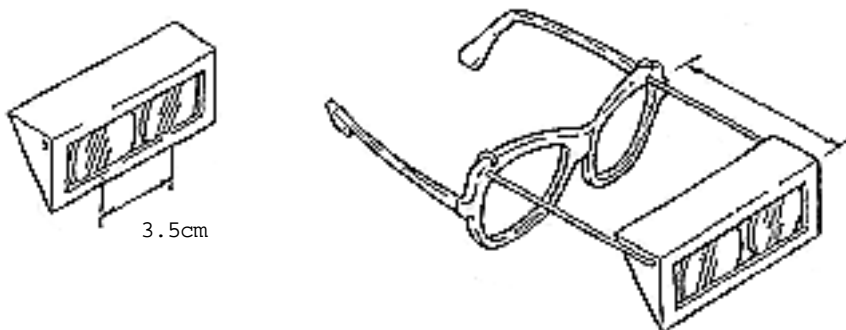

Alternative surgical loupe:

If you have a trial frame and a set of lenses used for subjective refraction you can use these to make an operating loupe: make a lens support in steel wire, so that a positive spheric lens is positioned at 8 cm from the eye, and centred nasally. The elements are fixed by binding them together with fine copper wire, such as used in a dynamo. This support is fixed in the trial frame, or it is part of a 'spectacle-frame' made in the same way. The magnification (M) for a lens of 4.5 D is X 1.56, and for a lens of 6 D it is 1.9 ($M = 1/(1-dD)$, d =distance between lens and cornea in metres).

The working distances are 22 cm and 16 respectively, (Beebe loupe, Fonda, has 14 D and 8 D prism base-in for each eye and gives a magnification of 3.5).

This is a summary of K. Maertens, Trop. Doctor 7 /86, pp 139-140.

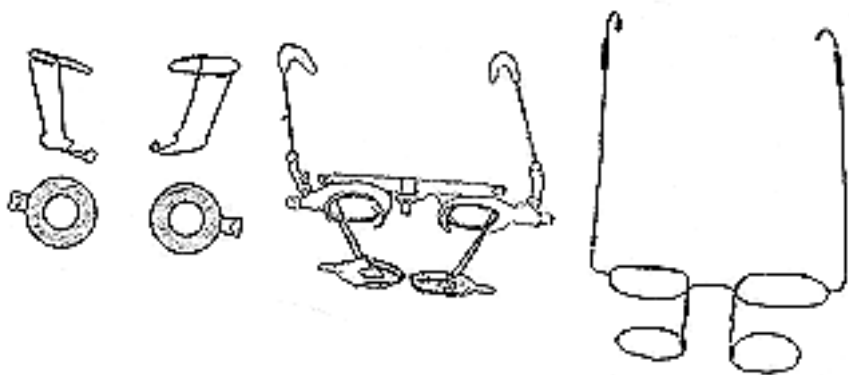

11 Microscopes and surgical lamps

The need for extra-capsular cataract-extractions will increase. In order to do this well a **microscope with co-axial light** will be needed.

Dr. Robert C. Welsh (1600 Onaway Drive, Miami, Florida 33133, USA) has made a portable microscope. This third world scope complete in the carrying case (33 lbs) is \$ 1800 and the floorstand (6,5 lbs) with stability struts and machined adaptor sleeve is \$169. An observerscope for teaching purposes is available. Conversion to slitlamp is easily possible.

Surgical lamp: Dr. Joseph Taylor, CBM refers to a cheap and very effective Eye Surgical Lamp that he designed in conjunction with Scan Optics (Eye operation lamp SO-911). It can be fixed to anything upright e.g. drip stand. It has 2 halogen bulbs and can be used off 220/240 volt AC or a 12 volt DCC car battery. Price \$330. Scan Optics ☛.

12 Surgical stand for supporting facial drapes

Surgical stand for supporting facial drapes during eye-surgery under local anaesthesia: this can be produced cheaply by any local welder. The metal stand fits around the patient's head at the level of the nape of the neck, seventh cervical vertebra. This allows surgical drapes not to rest on the patient's nose and gives the patient a "pocket of air" to breathe. This reduces the patient's sense of claustrophobia due to tight fitting surgical drapes touching the nose and mouth. The base of the metal stand consists of two parallel bars with intermittent joining supports. This bar slips under the patient's head and rests at the level of the patient's neck/shoulders. The single overlying bar is in the shape of a half circle and lies over the patient's nose/mouth. The length of the double-stranded base is approximately the width of the operating table. The width is 12 cm. to ensure stable support. The overlying single-strand curved bar is tall enough to allow the surgical drapes not to touch the patient's nose or mouth, but to fit easily on the upper cheek/lower eyelid. This creates an air space around the nose/mouth and reduces potential build up of CO₂. The patient must be warned not to raise his head suddenly to avoid hitting the metal bar. Baxter F. McLendon, Guatemala.

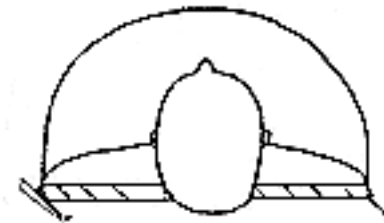

13 Making sponges

Instead of buying ready-made sponges, look for a thin sheet of 'viscose' in a shop of household-articles. Those are often yellow or light-blue and sold for kitchen-use. Cut triangles, or any shape you need. Try a small quantity first, not all qualities stand autoclaving, and some qualities loose small particles during use.

The same material can be used, as a bigger piece, to hold corneo-scleral needles or sutures. The bright colour helps to find it more quickly.

It lends itself also to the cleaning of instruments.

After use it can be soaked in cold water, washed, and autoclaved again.

14 Eye shields

A protective device to prevent any damaging pressure to the eye has to be applied quite often, for example when there has been a corneal laceration or other puncture wound to the eye. A shield prevents rubbing against the eye or pressure through the lid.

Procedure:

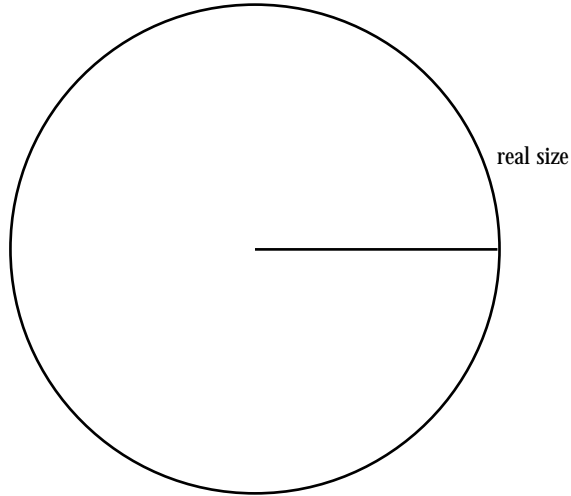

- cut a circle (diameter 6-7 cm) out of heavy paper, card board, or used X-ray film.
- cut along a radius
- tape or staple or glue it into shape.

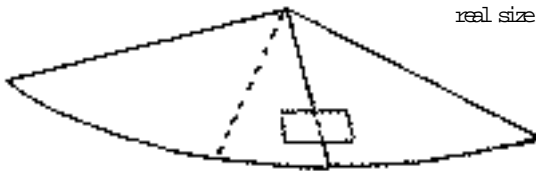

According to the needs, a central hole can be made.

The shield must rest upon the brow and the cheek. It can be kept in place by strips of adhesive strapping (or cellotape etc.), or by a bandage around the head. A rope through holes at the rim can help. But if this is the only way you fix the shield, it will not always stay in place.

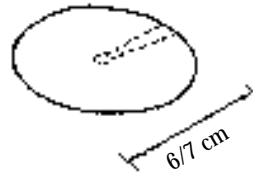
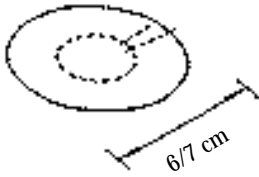
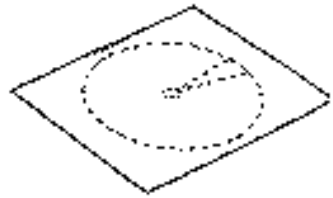
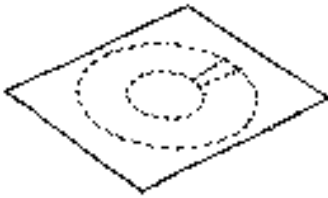

Suggestions from the field:

- Use a small aluminium souce cup, diameter about 7.5 cm, height 1.25 cm. The rim is already rounded, the bottom can be rounded if you want it to look like a real eye-shield.
- make holes in the cardboard or aluminium shield (2 mm). If this eye-shield is used without gauze it offers stenopaeic vision for the patient, and thus it will encourage the patient to leave it in place.

15 Plastic operating sheets

To avoid touching the skin of the eyelids and to obviate cutting the eyebrows you can cover the eye with a plastic sheet. Adhesive pre-sterilized sheet is expensive. Cut 14 x 14 cm squares of thin plastic (the thinner the better, like the quality used to cover dishes in a refrigerator, or plastic lunch-bags), take 10 sheets alternated with 11 slightly larger paper squares. One sheet should not touch the next sheet.

Roll these sheets up. Tie the roll with an elastic band. Boil or sterilize. Before packing or before use, a slit the size of the eye-opening is cut.

Don't dry the sheets, the moisture serves as 'glue'. Place a sheet on the eye before inserting the eye-holder, flatten it out to make it stick to the skin (only touch the corners). Insert the eye-lid retractor without touching lids or lashes with your fingers, in such a way that the eyelashes are covered.

16 Intra Ocular Lenses 'IOL'

- Reactions ITIR-newsletter 32: Dr. Bakker, formerly Weligama, Shri Lanka:
Uses Shah and Shah 104, Mod J-loop, 10 degrees angulated, UV abs, A=116.8. A fairly thick lens with blue PMMA haptics. Well packed in sterile plastic container, easy to open. Easy to insert but tough to rotate; final position close to iris. Switched to 106, identical to 104, but with reversed optics. A=118.5. This lens is also easy to insert but takes its position away from the iris. Price \$18. (Shah&Shah 🍏)
- Aftercataract: he acts as follows: in approximately 10 % of the cases it is not possible to get a clear posterior capsule during surgery, maybe as a result of an uveitis in the past. In those cases a primary capsulotomy is made. Those who complain about aftercataract afterwards are getting a capsulotomy with a 30 G needle 🍏 via the pars plana. This is done in the OPD behind the slitlamp.
- Letter of Dr.G.Venkataswamy Aravind Eye Hospitals 🍏.
He writes that they started to make IOL under the name Aurolab. 6mm optic part with 2 holes. 10 degr angulation, A 116,8: modified J, Short C or modified blue PMMA loops (so one type lens but 3 different type of loops). Price \$10 non-profit users. Commercial 15\$. Also microsurgery training courses are organised. For both: adress mentioned above.
- Appalens makes IOL's. Price \$10. Appasamy Associates 🍏.
- Ocular Surgery News september 1993: David J, Apple claims that the newer open loop Anterior Chamber Lens (ACL) can be used safely and effectively because they can be combined with intracapsular surgery.
- In this light the letter of S. Lewallen et al Arch Ophthalmol-vol 111, jan 1993 as comment on "Extracapsular Cataract Extraction in Developing Countries" is interesting: they claim technical difficulties and a 10% vitreous loss rate: difficult anterior capsule in mature cataract, weak zonulas, lack of sophisticated instruments when troubles. So an argument for ACL or none.
- Florida Medical Manufacturing USA 🍏 has a 'turn key' package for anyone interested to start producing IOL.

17 Surgical Technique for Vanadium Stainless Steel 50 mu. Sutures

By: J.G.F. Worst

Drawings: Wim Velt

Taken from: 'The Ophthalmic Toolbox',
a Jan Worst Research Group publication 

17.1 Introduction

Suturing materials vary as to their composition, thickness, biochemical and physical properties, etc. For obvious reasons sutures for ophthalmic surgery must be extremely thin.

Suture materials:

In older days absorbable catgut, natural silk, fine linen, hair or filamented rattails were in vogue as suturing materials. More recently synthetic fibers have been introduced. Most of the sutures are essentially non-absorbable, which gives them a high biochemical compatibility. Absorbable sutures are bio-incompatible and give rise to low grade inflammatory reactions.

The physico-chemical properties of synthetic fibers limit the possibilities for sterilisation.

Pressure autoclaving (up to 180°C) destroys their structure; sterilisation by chemical fluids is not advisable, because it adds an irritant. Furthermore, preservation of catgut and chromic catgut sutures in alcohol implies loss of strength with time. Remaining possibilities are ethylene-oxide sterilisation or gammairradiation, which are expensive high tech procedures. These financial factors limit the use of all these types of sutures, especially in developing countries.

An additional limiting factor is caused by the tendency of suture manufacturers to make the needle suture combination disposable by swaging the suture to the needle.

Conspicuously absent in the list of available sutures in ophthalmic surgery is vanadium stainless steel filament. This is surprising as stainless steel is a universally used suturing material in general surgery of bone, tendon, muscle, teeth, etc. The properties of stainless steel in general surgery are so well recognised, that one may wonder about its absence in ophthalmic surgery.

One outstanding property of the vanadium steel suture is the fact that it can be autoclaved at high pressures and at high temperatures. This makes the vanadium steel suture extraordinarily fit for use under adverse conditions in developing countries, where mass cataract surgery is performed (eye camps).

The costs of this suture, when commercially obtained, are equally high as those of synthetic suturing materials. An advantage of stainless steel, however, is that it can be inserted easily into a good (self-made) ophthalmic needle (see chapter 7).

Recognizing these advantages, I have used stainless steel sutures for 16 years now as a standard procedure for cataract wound suturing and for intraocular lens (medaillon Lens) fixation by means of an iris suture.

I have found the physical, mechanical and chemical properties of this suture outstanding. This chapter is an effort to give this suture the place it deserves in ophthalmic surgery, in particular in developing countries.

The stainless steel suture:

The standard ophthalmologic stainless steel suture which I use is 50 micron in diameter. This diameter proves to be a fortunate balance between the thicker sutures which are experienced as foreign bodies and the thinner ones which lack tensile strength. The surgical handling functions optimally with 50 mu vanadium steel.

17.2 The suturing technique:

It is important to note that the standard knotting techniques are inadequate for this material. If a standard surgical knot is made, the free ends of the suture stick up as barbed wire, a fact which has also been noted by Fasanella (1). Fasanella used this material in experimental and clinical eye surgery. Although he noticed a total biological inertness of the stainless steel suture, he observed severe mechanical irritation if a free end, however small, was sticking up.

The actual stainless steel suturing technique differs from the standard procedure used for synthetic fiber suturing.

The differences are:

1. Very short bites can and must be taken. Because there is no sloughing or tissue compression by the suture, any risk of late suture failure is prevented (fig 1 + 2).

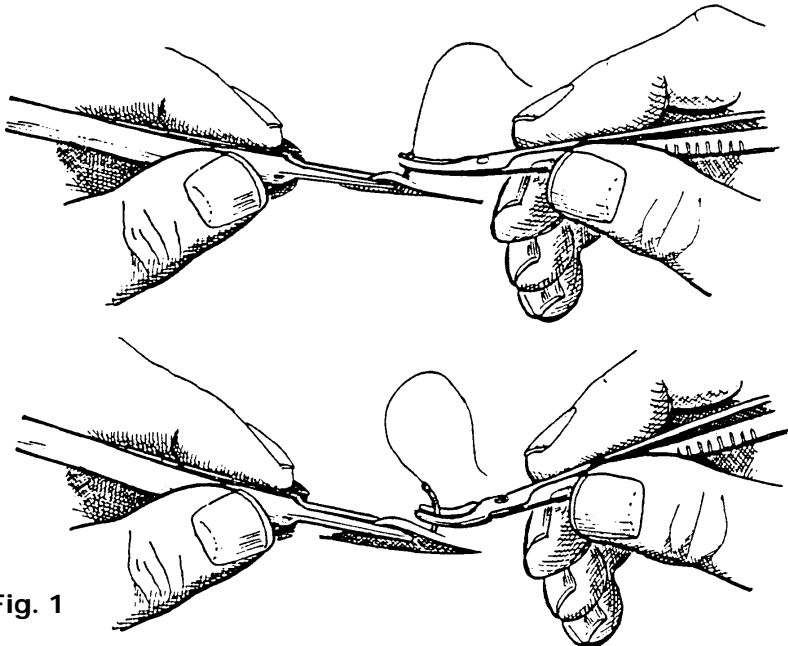
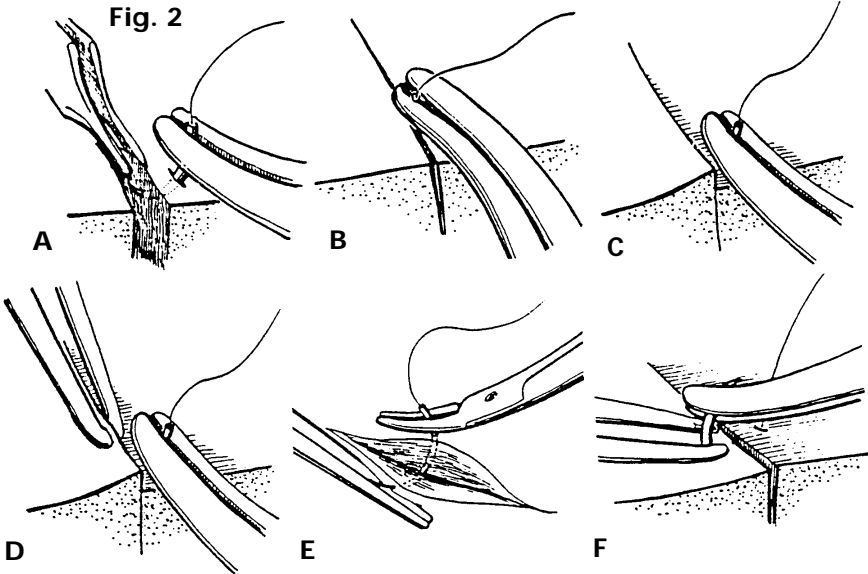
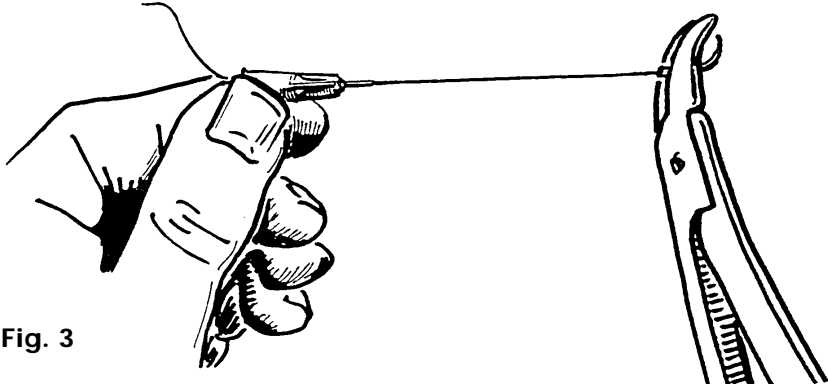

Fig. 1

2. The bite taken at surgery will remain the bite taken for the years to come.



3. The stainless steel must be repeatedly stretched lightly to remove 'kinks' (fig 3).



4. A double throw is made around the needle holder; the left hand moves away from the surgeon and the right hand is moved in the opposite direction (cross-handed technique). This results in a small ringshaped 'staple' (fig 4 + 5).
5. After formation of the 'staple', one suture end is broken off by pulling firmly. The other end of the suture is cut off flush with the sclera using Vannas scissors (fig. 6 + 7).

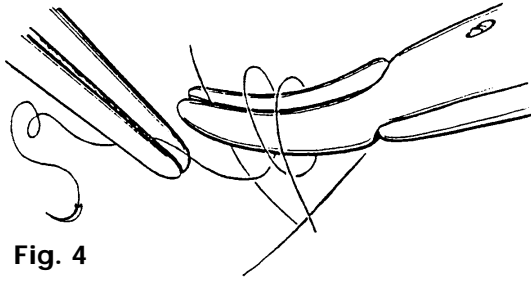

Fig. 4

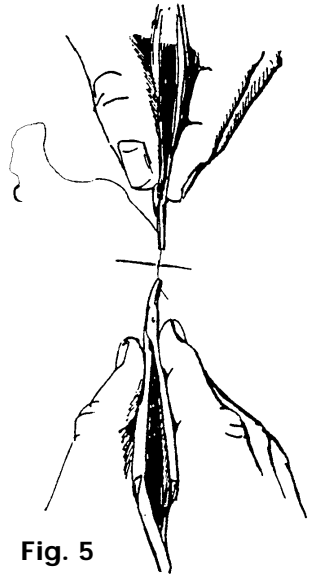

Fig. 5

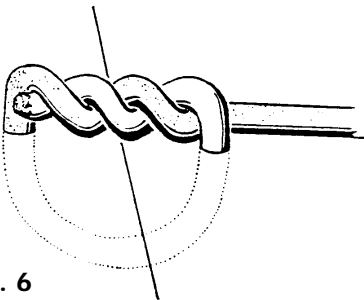
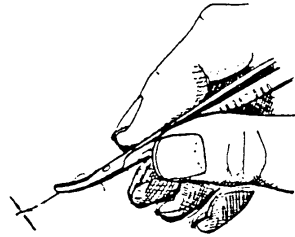
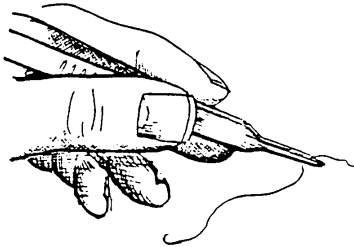
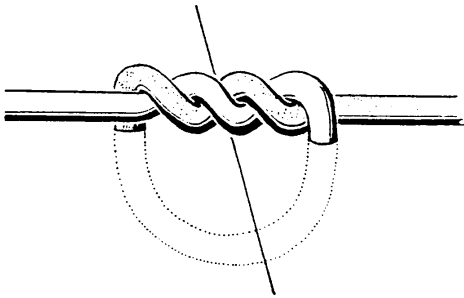

Fig. 6

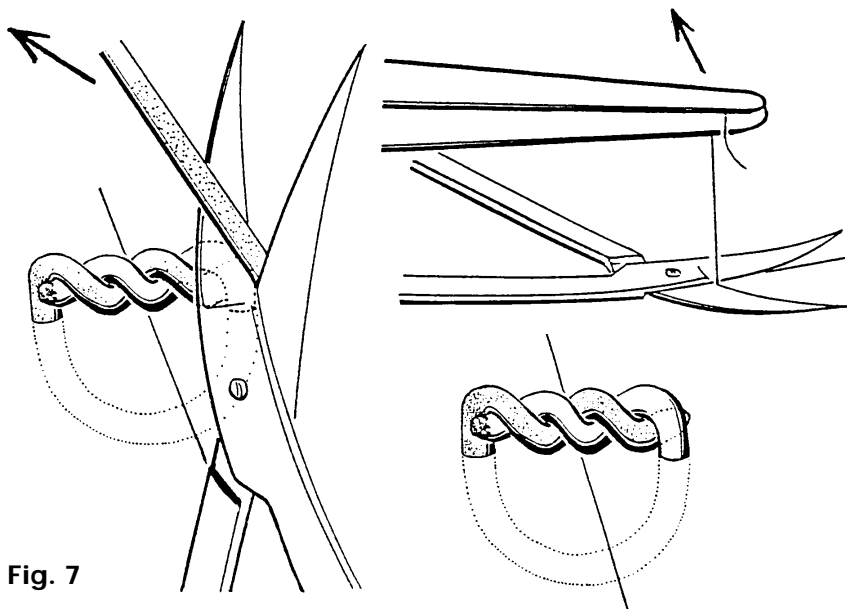

Fig. 7

The pull which is exerted on the suture can cause an undesirable amount of astigmatism. An alternative method which permits better control of astigmatism is to cut off both suture ends with Vannas scissors without pulling the suture tight.

For the sake of proper and strong wound closure no conjunctiva must be included into the suture knot. This means that, when a conjunctival flap is made (fornix based is preferred), the suture must be inserted under the conjunctival flaps.

17.3 Removal of the stitches:

Though hardly ever necessary, under certain conditions removal of the stitches is required, e.g. for correction of undesirable high astigmatism and in case of irritation, pain or haemorrhages caused by protruding ends (Note that in this case an incorrect technique has been applied in the first place!).

Removal of the stitches is done by the two needle technique (see fig. 8). One needle is passed into the ring of the staple, while a second needle is used to give counter pressure. It also should enter the small staple ring. This will cause the staple to snap open. The suture can simply be removed with a forceps by pulling on one of its free ends.

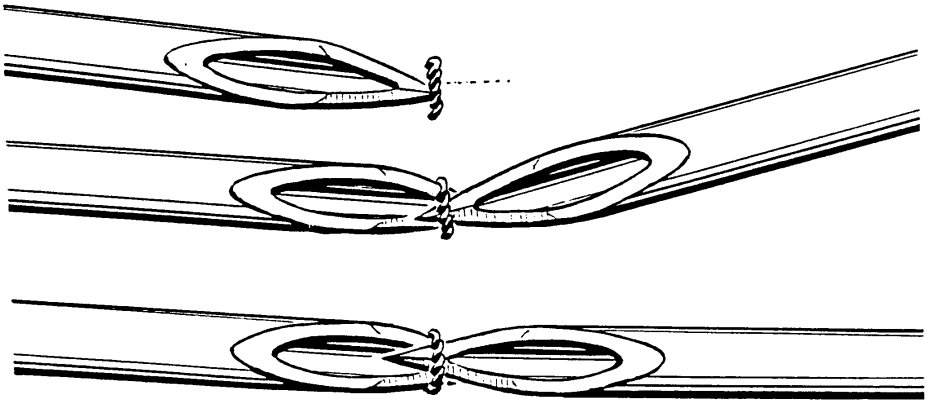
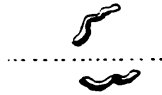

Fig. 8



17.4 Fine points of VA 50 micron suture use:

Stainless steel sutures have specific metallurgical properties, which set them apart from sutures made from polymer chemistry sutures. This metallurgical specificity should be kept in mind when using VA non-oxidisable sutures.

The different mechanical properties may be used to advantage, e.g. hardening by pulling (fig 3). They also may become a technical disadvantage (kinking, see fig. 3, unkinking).

A basic difference from polymer sutures is the hardness. In case the wrong knot is used, stainless steel becomes barbed wire! This is avoided by using the technique as described in paragraph 17.2.

Any use of the stainless steel suture should start with unkinking the crumpled stainless steel suture.

This is performed by holding both ends with a needle holder and give it a lightly stretch until the wire is lengthened several millimeters. The stretching should be minimal to avoid too much hardening. The final hardening should take place in the final breaking phase.

After making the double throw knot (never to be belayed with a second knot, as this results in 'barbed wire'), the suture is held on the one extremity by the surgeon or the assistant and the other end is pulled tight up and beyond the breaking point.

The result is that the suture breaks off flush with the corneo-scleral surface.

The second extremity must be cut with Vannas scissors. For this technique see again fig.7.

References:

(1) Freeman D., Fasanella R.M.: Use of fine alloy steel wire sutures in ophthalmic surgery; Arch. Ophthalm. 1955, Vol 53, pp. 404-406

18 lowering intra-ocular pressure (hypotony)

To lower the intra-ocular pressure before an operation several methods can be used. Such methods should be safe, quick, and easy, i.e. not require much skill or much time of a skilled person.

Methods:

1. **No materials needed:** firm pressure on the eyeball with the flat of the hand-palm for 5 minutes after giving retrobulbar anaesthesia is cheap and easy, but requires 5 minutes of a trained person.

2. **Rubber band:**

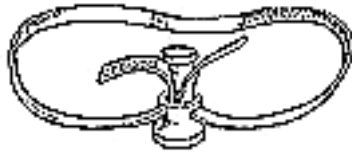

Cut a rubber band from the inner tire of a car (by cutting obliquely you can obtain any length), make it wider at one place, to cover the eye.
Pull the ends through a piece of pipe (electrical or water).

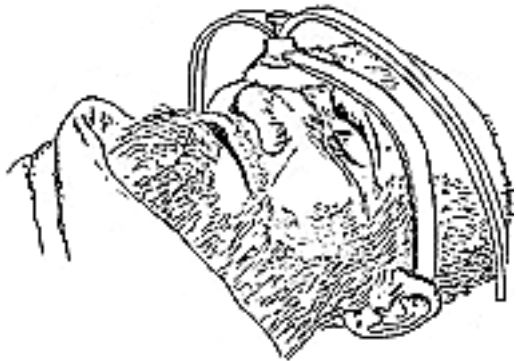
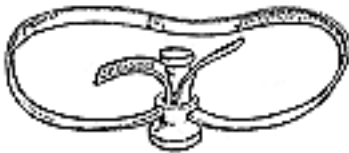

For use the wider part is placed on a gauze on the eye, the bands are pulled and held in place by a conic plug which is pushed into the pipe.

3. Rubber sponge ball:

Compress a soft sponge rubber ball over the patients eye by means of some tape which passes around the head. If the ball is truly soft, intra-ocular pressure will be raised very gently. The ball can be placed over a sterile gauze after prepping and giving the retrobulbar anaesthesia.

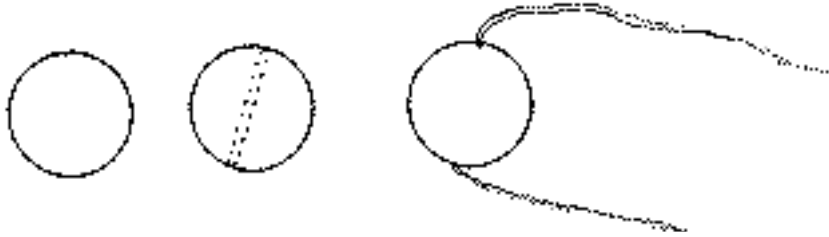

Instead of taping this ball to the head one can make a through and through hole in it by a red-hot rod and pass a nylon cord through this hole. This cord is wound round the head of the patient for 10 min.

4. Sphygmometer:



Place a small eye-pad on the eye, cover this with the infant cuff of a sphygmometer (use a light bandage to keep it in place) and maintain a pressure of 30 mm Hg for 30 minutes.

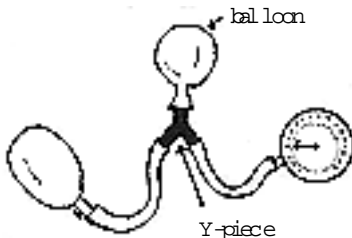

Or:

Lay a children's balloon on a gauze on the eye. The cuff is taken from a sphygmometer and replaced by the balloon (use an Y-piece if there are 2 tubes). The balloon is kept in place by a plastic eye-shield attached with a (leather) cord to the head of the patient. The sphygmometer is inflated to a pressure of 40 mm Hg for 10 minutes.

5. Weights:

- Take a bag with infusion-fluid and a tube connected to it (or any other plastic bag with fluid and a tube). Attach the end of the tube about 1 meter above the head of the patient, and leave it open. Lay the bag on the eye of the patient, and apply a bandage (or a sphygmometer-cuff) with so much pressure as to make the water rise to 60 cm above the level of the patients eye. One will see the intra-ocular pressure reflected in the level of the water in the tube, if not, the pressure is too high. Leave the bag for 10 minutes. When the water is coloured (drop of ink) it is easier to see.

After use the tube is closed (clamp, haemostat) and the bag is wiped clean. The bag can be used as often as you want to.

With this method you can measure the pressure applied, without having to use a sphygmometer, which is not always available.

- Fill a rubber balloon (or finger of a glove, etc.) with 300-500 gr. of mercury. This is smaller than the aperture of the orbit. As mercury is very toxic this balloon should be packed in another balloon. This is kept on the eye for 20 minutes.

Instead of mercury it may be safer to use sand, or pellets of shot (shot is used by hunters and by shopkeepers, to balance scales). As shot consists of lead it is heavy, and the pellets adjust to the shape of the eye in the same way as sand, water, or mercury.

6. Kuruvilla stand.

Imagine the handle of a 15 liter water bucket; instead of a bucket there is a 200 gr weight attached at each end. In the middle, where you would hold the bucket, there is a small man, made out of very thick (2-3 mm) wire, with his feet one corneal diameter apart. He has no feet, but stands on the 'stumps of his legs' on a small disc.

The heavy weights at the end of the handle keep the balance very well.

The instrument is put on the closed eyelid on a swab. It takes a few seconds to place it and one second to remove it.

It can be constructed in a simple workshop, or bought from Zabby, New Delhi, India 🍏.



19 Anesthesia for Pediatric intra-ocular surgery

Dr van Wijhe, anaesthetist, formerly in Kenya now in the Netherlands wrote the following about **Paediatric intra-ocular surgery**.

Intraocular surgery in children should be performed with the help of a competent anaesthetist. With the patient intubated and the depth of anaesthesia under control ideal conditions can be created. What are the possibilities when such an anaesthetist is not available? The only safe technique to use is intravenous (or intramuscular) ketamine. This is safe because the patient will continue to breathe with reasonable intact throat reflexes, so that tracheal aspiration of gastric contents is unlikely. An important drawback of ketamine for the ophthalmologist is its tendency to make muscles rigid and to raise the intra-ocular pressure. There is no solution to this problem; there is no technique in between proper anaesthesia and ketamine.

If you accept this the best and most economical way to go about ketamine anaesthesia is:

1. give **atropine sulphate** 0.2-0.5 mg. i.m 30' pre-op. The dose depends on the age, not the weight of the patient; the full dose being given from the age of 10 years. This does not influence the eye, not even in glaucoma patients. If not given, salivation and breathing problems are difficult to handle in an open eye situation.
2. Through an appropriately placed i.v. needle give 2 to 5 mg. **diazepam** (e.g. valium) and wait a few minutes. This will cause minor sedation and attenuates the effect of the ketamine. I.m administration of valium is unreliable, so give it i.v.
3. Estimate the weight of the patient and slowly inject 1 mg. **ketamine** per kilogram body weight i.v; the patient should slowly go into a state of anaesthesia, which can be tested with the cornea reflex. Sometimes it is necessary to increase the dose to 2 mg/kg. Use the 10 mg/ml ketamine solution for this.
4. If after some time (10 min.) an **extra dose of ketamine** is necessary to give a small increment (0.25-0.5 mg/kg). One hour anaesthesia calls for 3-4 mg/kg via the i.v. route.
5. **Postoperatively** the patient should be allowed to recover in a peaceful place but under supervision in case of emergency unrest.
6. An alternative method is to give the **ketamine intramuscularly**. 10 mg/kg **deep** i.m.gives 15-25 minutes of operating time. Use the 50 mg/ml solution. Additional doses should be 5 mg/kg. Besides being uneconomical this is not an elegant technique; waiting time can be 5 to 15 min after each dose. It should be reserved for the very small or the very uncooperative patients. Once they are anaesthetized there is of course no harm in continuing via the i.v.route.

M.Hogeweg (The Netherlands) writes: during eyecamps in Nepal we have been using ketamin i.m.(50 mg/cc)to full satisfaction. We insist in getting the body-weight of the child. The child should be without food or drink 4-6 hours before surgery. We give the child 0.25-0.5 mg atropine by mouth 2 hours pre-op. We use 8-10 mg/kg deep i.m. in the upper outer quadrant of the buttock. As soon as the child is asleep we give additionally a facial and retrobulbar block. Only rarely additional ketamine is needed. If needed, this should be 1/4 of the initial dose.

20 Replacing cyclocryocoagulation by cyclothermocoagulation

Reactions from the field: Dr. H. Tubbesing formerly in Cameroon writes:

Dr. Paul Pouliquen from France gave the suggestion to replace cyclocryocoagulation by 'cyclothermocoagulation': in case a filtering procedure to reduce ocular pressure has failed, a metal instrument heated to 100°C in boiling water is held for about 10 seconds to the sclera surface above the pars plicata of the ciliary body.

Personally he thinks a muscle hook does not seem to hold the temperature long enough.

Probably the best instrument is the Wordsworth Cautery of which the ball (not the tip) is firmly held to the scleral surface at a distance of 3-4 mm. from the limbus after having stripped the conjunctiva temporarily away in the form of a fornix-based flap.

His feeling is that 5 to 6 applications over 180° give already a satisfactory effect.

21 The Prevention of Infection in Eye Surgery

By: C. Koppert

The slightest infection of an eye is frequently disastrous to vision.

The use of an autoclave is often over-emphasized. However, to prevent post-operative infections several principles are important:

1. the correct surgical technique
2. sterile or well disinfected instruments
3. clean surroundings and the appropriate pre- and postoperative care

21.1 surgical technique

Handle eye tissues with care. Dead tissue enhances bacterial growth.

Work efficiently. The less time the globe is opened, the less chance for microbes to enter.

Start operating only when everything is ready for the surgical procedures. The most simple technique is often also the fastest. Make incisions large enough for their purpose. Make smooth wound edges. This promotes healing.

Suture every wound carefully.

The no-touch-technique.

The no-touch-technique is essential for intra-ocular surgery.

This technique requires that nothing which is not sterile may touch the eye. The instruments must be absolutely dry when ready for use. No instrument is to be used more than once into the eye without re-sterilization or re-disinfection. It is evident that everything which enters the eye must be free from microbes. It is just as important to prevent contamination of instruments during surgery. The needles are handled only by instruments, never by fingers. Suture material is touched only by a sterile instrument.



rail without sheet

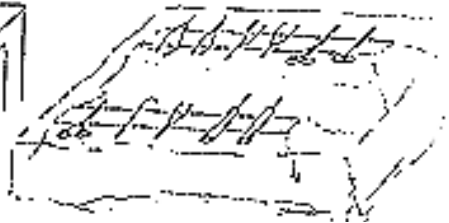

rail in use

It is practical to arrange the instruments on a kind of rail. Two (wooden) laths are covered with a sterile sheet. The instruments on the sheet are placed in such a way that the tips and handles are elevated 'in the air'.

21.2 Sterile and disinfected instruments

Sterilization is the complete elimination of microbial viability. Disinfection is making free from pathogenic organisms or rendering them inert.

Methods to achieve sterility and disinfection have to be effective, simple, quick, safe and economical.

Effectiveness is not easy to check.

Bacteriologists test the effectiveness of a method by using the method of sterilizing or disinfection after contaminating the instruments. Then they culture the instruments to check if any microbes remain.

Nurses and doctors work in different circumstances.

Therefore in vitro results (i.e. in the bacteriological laboratory) do not always correspond to in vivo results, as circumstances vary: instruments used for a 'clean' operation contain very little micro-organisms, at the other hand it is easier for a microbiologist in a laboratory to stick to the directions for use of a method than it is for a busy nurse, even more so when time is short and there is a shortage of instruments.

Simplicity is necessary: if a method is complicated mistakes are unavoidable and render the result unpredictable. Complicated methods require trained personnel, to avoid mistakes. Trained staff may be rare in remote areas.

Speed: a long sterilization time requires many sets of instruments or long waiting periods between surgeries, or tempt the staff to stop the procedure before sterilization is completed.

Safety: the technique should not harm instruments; blunt instruments cause untidy wound edges. If noxious substances remain on the instruments these remnants may harm the tissues, dead tissue enhances bacterial growth.

Economics include not only the price of the agent but also waiting periods, salary of the staff which has to perform the sterilization, etc.

Whatever method is used, first clean all instruments with water and soap. The presence of biological materials (blood!) inhibits germicidal action. Clean surfaces therefore are more easily disinfected or sterilized.

I- Methods of sterilization.

a. Steam under pressure, using autoclaves

Method:

- Vacuum achieved by a pump and controlled steam pressure.
- Steam temperature: 134 degr. C
- pressure: 3 Bar
- Sterilizing time: 3-4 min.
- Complete cycle: 25 min., including drying cycle.
- Items must be double wrapped.
- Autoclave indicator tape has diagonal lines which change from beige to brown during sterilization.
- Shelf life: 8 weeks.

Usage:

- Trolley packs, gowns, bi-polar leads, cryoprobes, etc.
- Strictly follow the instructions of the manufacturer.

Disadvantage:

- Usually needs electricity, although some autoclaves work on kerosene, propane or wood. If kerosene burners are used, you can use two smaller ones instead of one big one for heating, and remove one burner when the right temperature is reached.

Portable autoclaves.

Usage:

- Sterilizing time as for domestic pressure cooker.
- Not only metal instruments but also suitable for theatre linen- drapes, gloves, etc. because it has a drying cycle, which a domestic pressure-cookers lacks.
- Suitable for use with bottle propane, primus stove.

Disadvantage:

- relatively small capacity.

b. Steam under pressure- using a domestic pressure-cooker.

Method:

- follow manufacturer's instructions.
- Sterilizing time: - working pressures 10 lb/in -116 degr. C - 40 min.
 - working pressures 15 lb/in -121 degr. C - 20 min.
- The instruments can be wrapped in heavy wrapping paper.
- The air should be expelled thoroughly and the instruments must be high above the water. Catheters and other tubes should be open at both sides.

Usage:

- Metal instruments, including scissors and knives.
- Can be used on most heat sources, i.e. wood fire, charcoal, primus stove, bottle propane.

Advantages:

- excellent for small quantities. It is often better to sterilize small quantities more often instead of a lot once a day.
- Efficient, low cost. Suitable for field work.
- Spores will be killed.

Disadvantages:

- no drying process. This can cause instruments to corrode if left in container for several hours.

c. Boiling.**Method:**

- immerse instruments in water- preferably rain water, bring to boil i.c. 100 degr. C, boil for 30 min., which is adequate except under conditions where contamination by spore-bearing microbes is suspected.

Usage:

- Metal ophthalmic instruments, some kinds of plastic.

Disadvantages:

- Eventually it blunts scissors, knives etc., especially if the water is hard, i.e. contains lime and similar mineral deposits. These minerals can be removed by soaking the instruments in vinegar for 30 minutes, from time to time.
- Spores are not killed.

d. Steaming.**Method:**

- Use a container with a lid.
- Place instruments in a rack above level of water.
- Bring water to boil (100 degr. C), steam for 35 min.

Usage:

- Most metal ophthalmic instruments, including scissors, knives.

Disadvantage:

- Spores are not killed.
- Sterilization time is long.

e. Dry heat, using mechanical convection ovens.**Method:**

- Heaters are on the top. A motor blower is used to circulate the air. This eliminates ' hot spots' inside the chamber.
- Temperature: 150 degr. C.
- Sterilizing time: 2 hours.
- Complete cycle: 4 hours.
- Items must be doubly wrapped. Indicator tape: lines change from green to brown and from buff to yellow.
- Shelf life: 8 weeks.

Usage:

- metal instruments

Disadvantage:

- requires electricity

II Methods of disinfection.

Chemical disinfectants.

An ideal chemical disinfectant would be

- cheap,
- readily available,
- exhibit long storage and effective life,
- function quickly against all known microbial pathogens with equal potency but without the risk of toxicity to patients or staff,
- be easily disposed of,
- act upon cells by a fully understood mechanism requiring no special conditions of pH or temperature of diluting medium,
- be acceptable in all clinical situations over an impossibly wide range of dilutions,
- not be degraded or inhibited by biological materials (blood, faeces, sputum),
- odourless and non-irritant and
- not leaving unacceptable stains.

Naturally, no disinfectant matches these requirements, which are indeed only partly met by favoured disinfectants in restricted, often stringent, circumstances of use.

Medical staff instructing non-medical personnel in remote situations where only limited resources are available should perhaps concentrate on the following general precautions:

1 All disinfectants known have some important limitations of action. Thus, alcohol is virtually useless upon *Bacillus* and *Clostridium* among many other genera, while cetrimide can operate so poorly against *Pseudomonas aeruginosa* that it is often used in microbiology laboratories actually to select out this pathogen from mixed cultures. As *Pseudomonas* infections may lead to blindness, this latter disinfectant would be most inappropriate for use in, say, disinfection of instruments used in cataract surgery.

2 The presence of biological materials usually inhibits germicidal action. Clean surfaces therefore are the more easily disinfected.

3 Since temperature coefficient is related logarithmically to reaction velocity of disinfectants, fairly small temperature increments above microbial growth levels will yield considerable greater effect at constant disinfectant concentrations.

4 Disinfectants degrade with time and conditions of storage, some being especially susceptible. Hydrogen peroxide, for instance, in some concentrations as effective as formaldehyde against the *Rickettsiaceae*, can also deteriorate on storing as to be useless against these dangerous pathogens.

5 A limited selection of freshly prepared disinfectants for use in especially identified clinical situations, carefully explained and defined, gives best opportunity of effective continuous use.

Categories of chemical disinfectants.

a. Acetone.

Undiluted acetone is a good disinfectant. It kills *S. aureus* rapidly but is only sporistatic with spores of *B. subtilis* and *Cl. tetani*. It kills influenza virus but nothing is known about its action on hepatitis virus nor on HIV virus.

Method:

- Instruments are first cleaned with water and soap and then dried. Next a few minutes of immersion of the instruments in acetone are sufficient for disinfection.

Beware of hollow instruments, they must be carefully rinsed with sterile saline after blowing out the acetone with air. Take the instruments out from the acetone with a sterile forceps and not with fingers.

The instruments must be dry before use (a few minutes in open air will do).

Advantages:

- Acetone is economical and easy to obtain. The method is simple and quick and has a less blunting effect than boiling.

Disadvantage:

- It is inflammable but not explosive. Certain plastics may dissolve in acetone. Never let acetone touch human tissues, except the skin. Acetone vapours may irritate mucous membranes. To prevent evaporation and to facilitate transport a special stainless steel box has been developed (Ophtec, see end of this chapter)

b. Alcohols

These are generally active against vegetative forms of bacteria and fungi, between 60 and 95 % concentration. However, activity against viruses cannot be relied upon, especially where blood contaminates instruments or other surfaces. Chlorinated alcohol are the most effective and are of some use in skin disinfection.

Method:

- immersion of instruments for at least 10 minutes in alcohol 70 %. Rinse the instrument with water and let it dry before use because alcohol is harmful to the eye.

Disadvantages:

- includes ineffectiveness against spores. Inflammable and volatile characteristics. Tendency to precipitate proteins so as to protect virions.

Ethyl-alcohol still tends to be considerably and unwisely over-used.

Tincture of iodine, a preparation of 2 % iodine and 2 % sodium iodine in alcohol, has long been favoured for the pre-operative surgical disinfection of skin surfaces although allergic reactions may occur.

Method:

- immersion of instruments for one minute is sufficient but the iodine has to be rinsed off with alcohol, which has in turn to be rinsed with water, which has in turn to be dried before use.

Alternative chemical disinfectants.

c. Aldehydes.

Formaldehyde is one of the most reliable and best-known disinfectants, with a wide range of uses. It is effective both as a gas and liquid, is sporicidal, acts against fungi, bacteria and viruses at different concentrations, and is very cheap.

Formaldehyde is often used in a 5 % mixture with alcohol, and then reliably sporicidal in 24 hours at 25 degr. C. This concentration is often chosen for surgical instrument disinfection (Sykes 1972) while Finch (1958) advises a 20 % formaldehyde solution in white spirit for blanket disinfection.

In its gaseous form formaldehyde is evolved from a 40 % aqueous solution, and acts optimally at 75 % \pm 15 % relative humidity.

Special additional advantages are its availability and versatility- it may be combined with chambered steam, for example (Adams 1957) whereas some other disinfectants may be explosive even at low temperatures. It is often regarded as a standard disinfectant for surface treatments.

glutaraldehyde: not as irritant or toxic as formaldehyde, glutaraldehyde is of greater potency. As 'Cidex', the preparation will suffice for surgical instruments, glassware and selected non-autoclavable clinical materials, and will also disinfect in the presence of low concentrations of blood and other biologics (Snyder e.a. 1965). Though not as cheap as formaldehyde, it has found high favour with some justification.

Method (Cidex):

- Sterilizing time: a minimum of 10 minutes.
- Items must be totally immersed- with no air bubbles present, for at least the minimum time, then thoroughly rinsed under a running stream of sterile water.
- Cidex is a corrosive chemical, and should be rinsed off immediately if it comes in contact with the skin.
- Cidex is also used for decontamination of instruments after infected cases:
 - Soak the items for a minimum of 2-3 hours.
 - Rinse under running water.
 - Wash in cleaner, then sterilize in the usual way.

d. Phenols and gesols.

The newer derivatives of phenol are of more importance than the original (Lister's) germicide, halogenated compounds being mainly the ones of use in medicine. The chloroxylenols are only weak antibacterials, but chlorhexidine ('Hibitane') has become of accepted use for skin disinfection. Too prolonged use, however, will result in overgrowth by *Pseudomonas*, as will its use in too low an initial concentration (e.g. 0.1 %).

In the same category, hexachlorophane is effective and can be used in soaps or detergent combinations with enhanced effect.

It is especially useful, as it can be cumulative, when employed as hand lotions in clinics or theatres, where a 3 % solution with 0.3 % chlorocresol was found to be best (Lilly e.a. 1971).

There are many other preparations of this group available commercially without large general advantage.

Method:

- Hibitane with alcohol- for rapid emergency disinfection.
 - 100 mls of Hibitane Concentrate
 - 150 mls of water
 - 750 mls of alcohol (95 %)
 - 1 gm of Sodium Nitrite (anti-rust)

Usage:

- Disinfection of metal instruments, especially sharp delicate ones; also plastic equipment.
- Disinfection time: 3 minutes.
- Change solution weekly.

e. Beta propriolactone

A more effective disinfectant than either formaldehyde or ethylene oxide, it is sporecidal and leaves a non-volatile residue as does the former. Of use for special surgery instruments in liquid form or for the gaseous decontamination of wards or infected rooms.

f. Soaps

The germicidal capacity of soap has been understood for almost a century. the principal mechanism of action appears to be in removing biologics and increasing the solubility, with a minimal direct disinfecting effect. Main uses are in combination with phenol derivatives or newer synthetics.

g. Halogens

Chlorine is most appropriately used with a detergent, since protein neutralizes its effect. Those who recommend a 1 % aqueous solutions for rapid disinfection of hands usually advise the availability of a thiosulphate solution to remove the offensive odour. Its corrosive action upon metals renders chlorine unsuitable for instruments, but it has some uses still in disinfection of cleaned glassware, as in clinical laboratories.

21.3 Remarks on clean surroundings and pre- and postoperative care.

a. The surgery room.

Air circulation has not been considered of great importance when eye surgery is of short duration. Under primitive circumstances airborne micro-organisms suspended in dust may be dangerous and have to be reduced.

The operating table and the surgeon's and assistant's stools should be washed with water and soap. If the floor is of poor quality and cannot be cleaned properly, regular sprinkling is useful to prevent air-borne infection.

Be aware of too high a humidity, which enhances bacterial growth.

The windows of the room must be screened to prevent insects entering. Flies should be kept out or killed to prevent fly-borne contamination and distraction of the surgeon and her or his assistant.

b. The patient

The patient should be examined for infection of the eye-lids and lacrimal sac. If present these should be treated first, as well as infection elsewhere on the body. Many surgeons prefer to put an antibiotic ointment in the conjunctival sacs the night before surgery. Also all the lashes of the upper lid are cut short with scissors, the blades of which have been dipped into sterile 'vaseline' petroleum jelly.

Skin preparation: the eye lashes, lid margins, lids and eyebrow are cleansed with iodine or other suitable disinfectant.

Another possibility to reduce the risk of contamination from the eye-lids and eye-lashes would be to cover the eye-lashes and surroundings with a plastic sheet (see chapter 'other items').

Irrigation of the anterior chamber, as in extra-capsular cataract extraction, requires sterile normal saline or Ringer's solution. When home made irrigation fluids are used it is wise to put a micro-pore filter between the syringe and the canula. This item not only will catch bacteria but also the very small particles from the irrigation fluid. These filters are safe but expensive.

c. The towels

The towels draping the patients head (and body) can be sterilized in an oven for at least 1 hour at 150 degr. C. Another possibility is washing and boiling the towels in water with soap followed by ironing with a hot iron until the towel is dry. Then store in a sterile box.

d. The surgeon and assistant

In these times of HIV, wearing of surgical gloves is necessary. An alternative is to use one pair of gloves for more operations, and disinfect between operations. When instruments are contaminated during surgery, immerse the instrument in acetone for 2 minutes. Let dry before use, for acetone is harmful to eye tissue (keep a lid on the acetone box).

e. Post-operative care

A well closed corneal-scleral incision won't allow penetration of micro-organisms. Nevertheless most surgeons apply antibiotic ointment to the lower fornix at the end of the surgery.

Important instructions to the patient are: don't touch your eye! Don't rub your eye!

A protective eye-shield (with or without holes) is described in the chapter 'dressings'.

22 Chemical disinfections

22.1 Properties of disinfectants

A literature review was done to answer the question which disinfectant can be used for instruments for eye-surgery. A specific advice regarding the best choice is not given, as little will be known about the pathogens most important in your circumstances. The most important is to clean the instruments well before disinfection, instruments coming from an operation contain very few micro-organisms anyway.

The table below presents disinfectants in order of possible preference of choice, without taking availability, price, time, simpleness, etc. in account.

	viruses					
	gr +	gr -	lip	hydr	fungi	spores
pressure cooker	+	+	+	+	+	+
boiling in 2% soda sol.	+	+	+	+	N	+
peracetic acid	+	+	+	+	+	+ cor
beta propiolactone	+	+	+	+	+	+ carc
glutaraldehyde	+	+	+	+	+	+l
hypochlorites	+	+	+	+	+	+l ± cor ,irr, om
iodophors	+	+	+	+	+	+l ± cor,om
hydrogenperoxide	+	+	+	+	+	+h
formaldehyde	+	+	+l	+l	+	+l bit cor, irr ,carc
acetone	+	+	+	+	N	st coag.blood inact
ethylalcohol	+	+	%	%	+	st protein precip.
boiling in water	+	+	+	+	N	% cor
isopropanolol	+	+	%	-	+	st protein precip.
iodine	+	+	%	%	%	N cor om
sodium hydroxide	+	+	+	+	+	+h
phenolic compounds	+	+	+	-	+	st cor
quaternary amm cps	+	%	-	-	+	st cor for Al ,soap om
mercury compounds	st	st	-	+	+	st sensibilisation ,om
chlorhexidine	+	%	-	-	st	st allerg, soap, om
hexochlorophene(alone)	%	-	-	%	+	N
+	cidal					
+?	not all data affirmative					
+l	cidal if long exposed					
+h	cidal at high temperatures and/or high concentrations					
-	noactivity					
%	not equally active against all species					
carc	carcinogenic					
cor	corrosive					
hydr	hydrophile					
irr	irritation					
lip	lipophile					
N	no data available					
om	organic material inactivates					
st	static					

Literature

Sterilization of ophthalmological instruments, by M. R. Brouwer and P. Hardus, Tropical Doctor oct. '88, page 174-176, vol 18.

In the table mentioned above **HIV (AIDS)** virus is not yet included.

Sodiumhypochlorite 0.1 %, chloramine 2 %, isopropylalcohol 70%, povidoniodium 2.5%, formaldehyde 4 %, glutaraldehyde 2 %, and hydrogenperoxide 6 % are effective, (B. van Klingereren, e.a., Ned. Tijdschr. v. Gen. '88, 132, nr 46, page 2096-2100, J. Huisman, idem page 2100-2101, or WHO AIDS series no 2, MMWR '88;37:377-88 and other publications)

22.2 Acetone box

By: J.G.F. Worst

Acetone sterilization with 100% anhydric acetone is an excellent alternative to autoclaving, chemical sterilization or gas-sterilization of instruments. The action of acetone is based on the biochemical disruption of the lipid membranes of pathogenic organisms.

The basic approach to acetone sterilization demands careful cleaning and drying of the instruments. Sterilization of hollow instruments with acetone is possible, but requires careful internal cleaning of the tubes and canulas after sterilization, in order to prevent acetone from entering the eye inadvertently.

For safety sake hollow instruments probably can better be sterilized by autoclaving. Sterilization of hollow instruments requires filling of the tubes and canulas with distilled water. Balanced salt will cause formation of salt crystals, which will block tubes. Careful drying of the instrument is essential, since water will dilute the acetone, which diminishes its sterilizing capacity.

By simple careful washing with salt and water the bioload on metal instruments will already be very low. Any remaining pathogenetic organisms will be killed by acetone 100 %.

Acetone is volatile, but not explosive. Only direct fire will light up the acetone, in which case it becomes a serious fire hazard. The risk, however, is still not of the kind of ether ignition and explosion, as there is no direct gaseous mixture explosion (no 'flame front effect').

A further disadvantage of acetone is its toxicity, wherefore it shall be kept **in a closed box**. A special closed box has been constructed for keeping and sterilizing ophthalmic instruments. This is the I.T.I.R. acetone box, which has a tightly closed lid with a safety lock and a special silicone internal sealing plate. The internal part of the acetone box may be filled with foam plastic, which will not be dissolved in acetone and will keep the instruments from moving while the box is transported. The acetone may be left in the box **on condition no wet instruments are placed in it**.

To place the instrument on the surgical table, they can be simply removed by a forceps or artery clamp. **Do not enter the acetone with ones own fingers**, since this will bring greasy material and water into the acetone, which reduces its sterilizing capacity.

The instruments, when placed on the surgical table, will evaporate their acetone covering in a few seconds. Note, however, that for instance locks or complicated scissors require a longer time for evaporation of acetone. Leaving the instruments a few minutes on the instrument table is a safe time to wait for full evaporation.

The acetone should be used in a well ventilated operating room and not in closed areas without proper air circulation.

Directions for use:

- Before sterilization the instruments should be cleaned with hot water and soap and carefully dried to prevent water from being added to the acetone.
- The dry instruments are put in the box filled with 100 % acetone and sterilized for a few minutes.
- When the instruments are taken out it is recommended to shake them to make sure that all acetone is removed even from hidden corners.
- Hollow instruments should be washed out first with air and then with saline before use.
- For further evaporation the instruments are put on the sterile table for a few seconds.
- Never bring instruments immediately from acetone to the eye!
- After the operation the instruments are carefully cleaned again with hot water and soap and after drying them may be put back in the acetone sterilization box.

Caution: certain plastic materials may dissolve in acetone

Literature: Robert C. Drews

For transport: acetone can not be taken with you in an airplane.

Danger code: IMCO 3.1 VN 1090

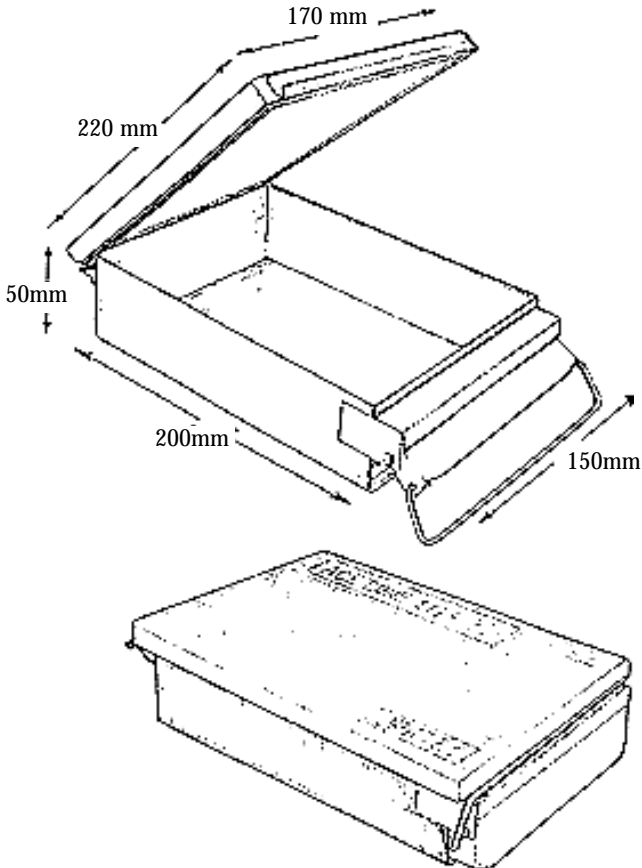

22.3 Additional remarks

A monsoonbox can be used to keep surgical instruments, microscopes and hand-lenses and other lenses free from fungus growth during the time humidity is high, in a hot climate. Put a small electric bulb (5-15 W/220 V) into a closed cabinet. The warm air has a lower relative humidity than the air at the ambient temperature (in high humidity climates fungus can grow through a steribag).

Disinfection of Goldman tonometers against Human Immunodeficiency Virus Type

1. Pepose J.S. et al. Arch Ophthalmol 1989, 107: 983-985

In a study it is clearly demonstrated that 3% hydrogen peroxide or 70% isopropyl alcohol swabs both provide an effective means of disinfecting goldman tonometers against HIV 1 (the AIDS virus).

Preoperative cleaning of povidone iodine 5% was evaluated in a multicenter study. Postoperatively the solution was harmless to the eye. Microbiological investigations showed a significant decline in the number of colonies after treatment. It is important to use the solution between lashes and in the fornices; Lagoutte, Journal Fr. Ophthalm 15:14-18, 1992

23 Taking care of instruments

Text: Danny Haddad

Ideas: J. G. F. Worst

Extracted from: 'The Ophthalmic Toolbox',
a Jan Worst Research Group publication 🍏

Cleaning surgical instruments:

- Untighten the instrument in order to be able to open the instrument completely. This way no dirt will stay inside the joint during cleaning.
- Use a gauze with water and soap (soft soap to avoid damage to the scissors, if soap powder is used, dissolve it first in water) to clean the instruments.
- Make sure that all the dirt inside the lock is removed. Dirt inside the joint will make it more difficult to open and close the instrument. It will also increase rust formation.
- After cleaning, dry the instruments.
- Put a cover around the tips of the instruments, e.g. a piece of a silicone i.v. tube.

Prevention of rust:

- Never sterilize iron and stainless steel instruments at the same time. The iron will precipitate on the stainless steel, which will cause rust. Also iron parts of the autoclave can cause this type of rust
- Old instruments are often made of chromium plated iron. If the chromium is damaged, the iron will precipitate on other instruments during sterilization.
- Rust can be removed by using a brass brush.
- Another method is soaking the instruments overnight in Coca-Cola. This soda will dissolve the rust (also a mixture of lemon and salt will do)

Chalky deposits.

Chalky deposits, caused by boiling with tap-water instead of with aqua destillata, can be removed by putting the instruments in vinegar for 30 minutes.

24 Sharpening of scissors

By: J. G. F. Worst and Danny Haddad

Drawings: Wim Velt (WV) and Danny Haddad (DH)

Taken from: 'The Ophthalmic Toolbox',

a Jan Worst Research Group publication 

The techniques written in chapter 24 and 25 were taught to us by the maintenance department of Lameris B.V. at Groenekan, The Netherlands. During ATO projects in Africa the techniques were adjusted to be usable under all conditions.

24.1 Equipment

- a frialit degussit whetstone
- an Arkansas stone
- a triangular file
- a rattail file
- a set of instrumentmakers screwdrivers
- an aluminium block
- a small hamer
- a good quality metal hacksaw
- a pair of flat or round tipped pliers

24.2 Introduction

Before starting to sharpen a pair of scissors it's good to first have an idea how scissors work.

Two surfaces of the scissor are of major importance, i.e. the inner surface and the cutting surface (see fig 24.1 and 24.2A cross section of a pair of scissors).

The angle between the inner and the cutting surface form a sharp edge. The two sharp edges of both blades are cutting the tissue. If a pair of scissors become blunt, the cutting edges are rounded off (see fig. 24.2B). These round edges are not able to cut the tissue anymore, instead it will clasp the tissue.

A rounded edge may be detected easily by using the reflection of light on the cutting edge. If the scissors are blunt, light will be reflected from the cutting edge, while a sharp pair of scissors won't reflect light from the cutting edge.

To test a pair of scissors: take a sliver of cotton wool or a piece of glove rubber, and try to cut it with the scissors. If the scissors are blunt the tissue will be clasped. This way you are able to see if the tip of the scissors cuts properly, or where the scissors are blunt. Never test a pair of scissors on paper, paper is a very hard material and will blunten the scissors.

24.3 The basic principle of sharpening scissors

The basic principle of sharpening scissors is to recreate a sharp cutting edge. This is achieved by sharpening the **cutting surface**. Never touch the inner surface of the scissors with the sharpening stone, because that will damage the scissors! Try to sharpen the cutting surface along the same angle with the inner surface as it used to be. If the cutting surface and the edge are severely damaged and a new angle has to be made, keep the angle between the inner surface and the cutting surface between 0 - 15°.

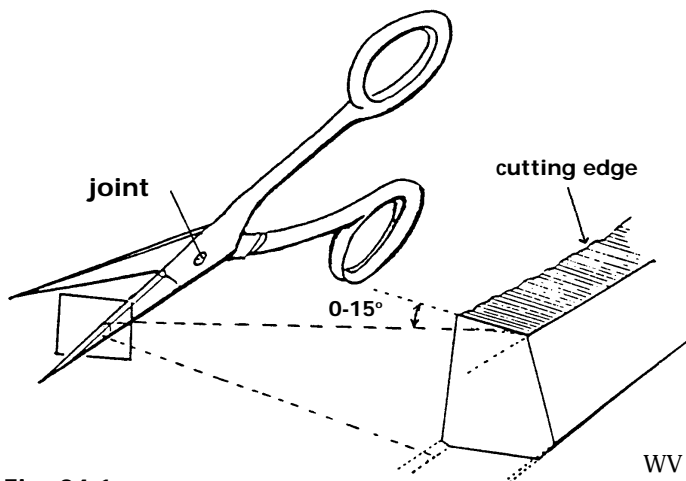

Fig. 24.1

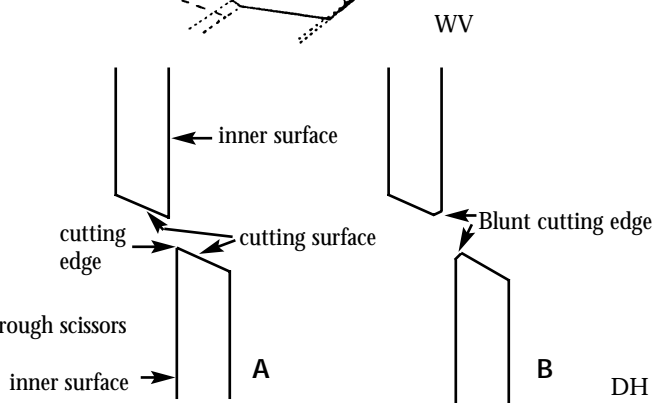

Fig 24.2 Cross section through scissors

A. Sharp scissors

B. Blunt scissors

During the sharpening procedure the direction of the sharpening movement has to be checked. If the sharpening direction is from the out side of the scissors towards the inner side, there will be a burr formation on the inner side of the scissor. Before closing the scissors this burr has to be removed, otherwise it will blunt the scissor again. The burr can be removed by scratching it off with your finger nail or with a very fine round whetstone removing it with a turning movement.

24.4 The sharpening of normal scissors:

For sharpening normal (i.e. not microsurgical scissors) a very fine Arkansas whetstone is used. The smoother the surface of the whetstone, the smoother the uppersurface will become (and the sharper the scissors will be). A small amount of oil (e.g. sewing machine oil) is used to smoothen the stone. Put the stone on a table.

The scissor is now put on the whetstone with the cutting surface flat on the whetstone (see Fig. 24.3).

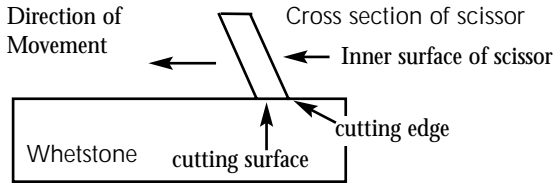

Fig 24.3

DH

To check if the scissor is at the right angle (i.e. with the cutting surface flat on the whetstone), use a bright light. Let the light shine from behind you. If the cutting surface is rotated a little bit a shadow will be formed underneath the scissor. Rotate the scissor till there is no shadow appearing anymore underneath the cutting surface.

Move the scissor in a forward direction with the inner surface facing you (see fig 24.3). If the scissor is too big to fit on the stone completely, make a movement from the tip of the scissors towards the lock, make sure that during one stroke the whole surface is covered.

Do not use too much force to press the scissor on the stone, let the scissor slide gently over the stone. The scissors should be sharpened by repeating the movement.

24.5 Sharpening microsurgical scissors

For sharpening ophthalmic microsurgical scissors a small triangular degussit stone (width 4 mm.) is used. The scissors are held in the left hand (or in the right hand for left handed persons) and the stone is moved over the cutting surface of the scissors. It is important that the surface of the sharpening stone is held completely parallel to the cutting surface of the scissors. In this way the angle between the inner and cutting surface is preserved. Start at the tip of the scissor and while moving the stone in a forward direction, slide sideways towards the lock to cover the whole surface with one stroke (see fig 24.4).

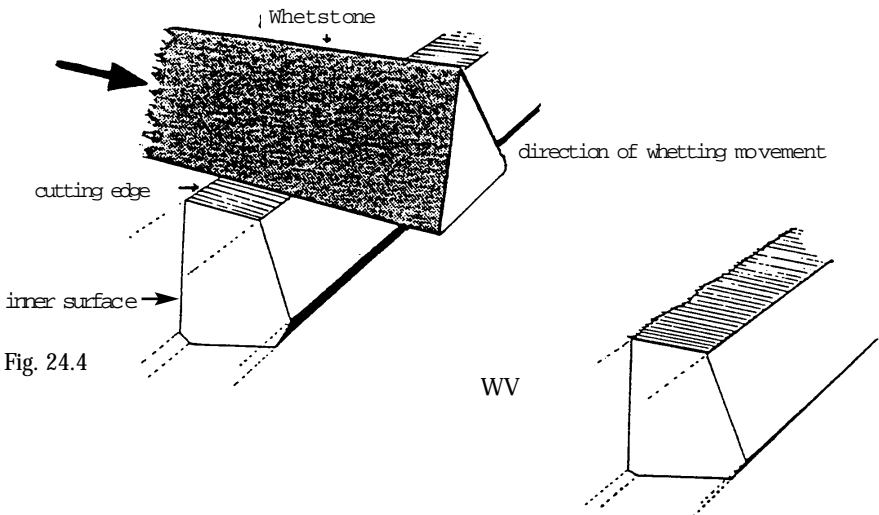

Fig. 24.4

WV

Note: Since this surface is very small a bright light can be used. The reflection of the light gives an indication of the angle of the cutting surface. When the light is put in front at eye height the brightest reflexion of the cutting surface will indicate that the cutting surface is horizontal.

24.6 The joint of the scissors are too loose

Another problem that occurs quite often, is that the joint of the scissors is too loose. If the joint is too loose the two legs of the scissors are too far away from each other and the tissue will be clasped between the scissors. Since most scissors are joined together with a rivet and not with a screw, the rivet has to be tightened.

This is done by putting the rivet with one side on a metal underground (e.g. a benchvice). Hit carefully with a small hamer on the otherside of the rivet, so it will smallen and reduce the distance between the two blades of the scissors. Better is to use a pendriver. Put the tip of the pendriver on top of the rivet and hit with the hammer on the otherside of the pendriver.

Test the scissors after every hit, to make sure that the joint does not become too tight.

25 Repair of surgical instruments

Text: D. Haddad

Idea: J. G. F. Worst

Drawings: Wim Velt (WV) and Danny Haddad (DH)

Extracted from: 'The Ophthalmic Toolbox',
a Jan Worst Research Group publication 🍏

25.1 General:

1. Worn out ribs

A lot of instruments have a ribbed innerside at the tip. When these ribs are worn out, the grooves can be enlarged with one of the edges of a triangular file.

2. Lock:

If the lock at the back of the instrument do not hold anymore, bend the legs of the instrument towards eachother.

3. Tips are not closing

When the instrument is closed completely, the tips are still open. The tips are probably bend, correct this with a pair of flat tipped pliers.

4. Tips are not aligned

- If the tips don't align properly anymore, (one of) the tip(s) is bend.
- If only one of the tips is bend, try to straighten it with the flat tipped pliers.
- If it is not obvious which tip is bend, both tips can be pushed manually in the right direction. **Note:** Don't use much force, rebend the tips little by little.

25.2 Micro surgical forceps:

There are three major categories of micro surgical forceps:

- the corneal forceps, toothed (see drawing 25.1) or with notched jaws (see drawing 25.2).
- the suture tying forceps, with a platform (see drawing 25.3).
- a combination of the two above, with teeth and platform or with notched jaws and platform (see drawing 25.4).

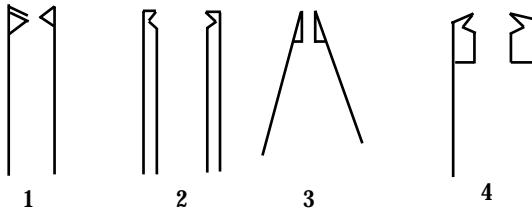

Drawings 25.1 till 4: Sketches of the different types of forceps

DH

The corneal forceps:

The forceps don't hold anymore

1. most common with the toothed forceps is that one of the teeth is bent. If the two teeth are bent towards each other try to open them again by pushing a knife between the blades. If the single tooth is bent straighten it with the flat tipped pliers. Be very careful, the teeth will break off very easily.
2. one of the teeth is broken off. The forceps can now be converted into a notched jaw forceps.
 - Shorten the other leg with the hacksaw, till both legs have the same length (see fig. 25.1)
 - Round both tips with a file, without touching the inner surfaces (see fig. 25.2).
 - file a groove in one of the inner surfaces with the edge of a triangular file. Also a round (rattail) file can be used (see fig 25.3) but this will lead to a bigger groove.
 - file a notch, at the same distance from the tip, in the other jaw. The two notches should be opposing each other completely. This can be tested by closing the jaws (do this at an early stage of the filing)

Now the forceps can be used as cornea forceps with notched jaws.

The suture tying forceps:

The platforms of both jaws should be closing completely.

If the tips do not hold the suture anymore the platforms might be worn out. To flatten the tips, grab a piece of very smooth sandpaper (P1000) between the jaws of the forceps. The sandpaper will now be completely aligned with the platforms. First smoothen one platform, then turn the forceps around and smoothen the other side

25.3 Needleholders

Testing a needle holder: if you can stretch a hair on your arm with the bit of the needle holder it closes properly.

The needle holder does not close properly:

- See 25.1 General
- The joint is loose: see scissors, chapter 24.6.

The micro surgical needle holder has lost its grip:

Smoothen the innersides, see 25.2 The suture tying forceps

Dr. B. McLendon writes:

it is often possible to repair our surgical instruments especially forceps with the following method:

a rubber or clear plastic sleeve is placed over each blade of a surgical hemostat (curved or straight). Operating microscope or surgical magnifying-glasses are used to obtain some magnification.

It usually takes a little working with the bent instrument, a little patience and some trial and error but the results are often quite satisfactory.

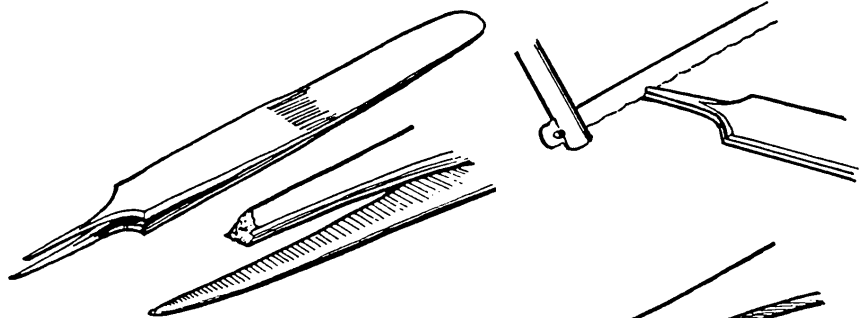

Fig 25.5

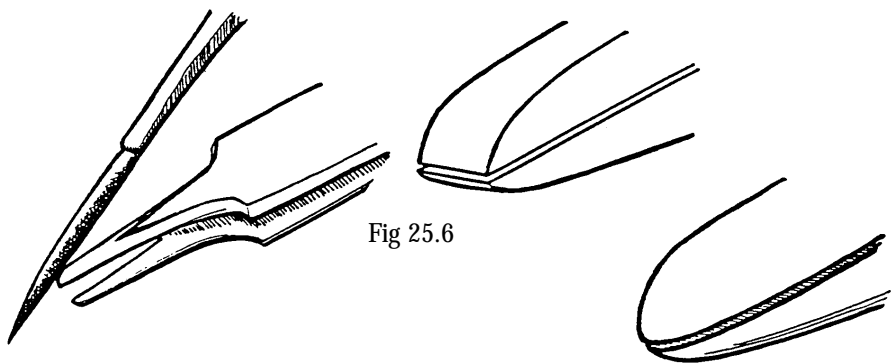

Fig 25.6

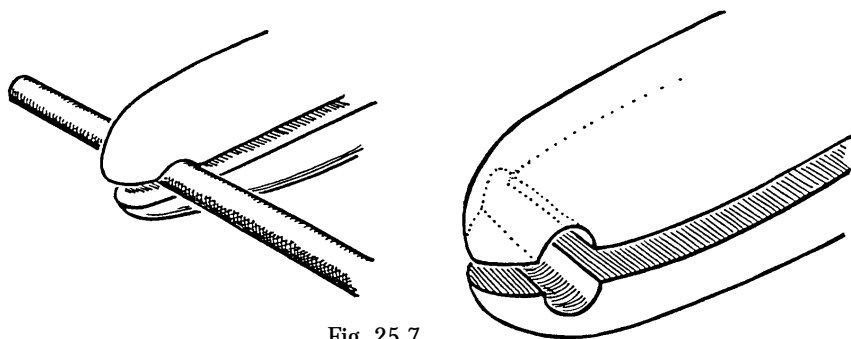

Fig. 25.7

WV

26 Low vision

Low vision: Dr N.C.Desai The Tarabai Rotary Eye Hospital and Research Centre E-22 Shastri Nagar Jodhpur 342001(Rajasthan) India wrote:

prevalence of low vision cases in the outpatient department is 0.13%.

His experience is that the acceptance or compliance for the distance telescopes and near telescopes is virtually nil. The best acceptance gives high additions for near.

Comment: Simple means of low vision aids for reading are magnifying glasses. If these are not sufficient to help the patient to read newspaper-print a special reading glass can be prescribed for only one eye. The strength of the reading glass can be determined by the reciprocal of the visual acuity of the Snellen Chart at distance. If the visual acuity is 0,1 or 20/200 or 5/50 the addition should be +10 D to enable the patient to read print at 10 cm distance. If the visual acuity is 0,05 the addition should be +20 D for reading at a distance of 5 cm.

When prescribing high adds for both eyes it is important to realize that maintaining convergence is necessary and that prisma's have to be added. Exact calculations are very difficult.

Mr. Wegman, optician the Netherlands gives the following basic rules for nasal decentration of positive glasses:

A: low addition, not more than 2 diopters:

1.small pupillary distance till 64 mm	1 mm per glass
2.64-70 mm	1,25 mm
3.70-74 mm	1,5 mm

B: higher addition, not more than 4 diopters:

1.small pupillary distance till 64 mm	2 mm per glass
2.64-70 mm	2,25 mm
3.70-74 mm	2,5 mm

When the addition is more than 4 diopters extra prisma's have to be given on top of the above mentioned.

addition	+4,5	3 prisma's extra	1,5 per glass
addition	+ 5	5	2,5
addition	+ 5,5	7	3,5
addition	+ 6	10	5

27 Drugs

Largactil (chlorpromazine):

A painful blind eye is a common condition in the tropics. **Evisceration or enucleation** is many times not wanted. Retrobulbar injection with alcohol is a known alternative.

Alcohol is many times not available. An alternative is largactil 2,5%.

(J.Fr.Ophthalmology 1980 3 397-399 C. Fiore and others: Effet de l'injection retrobulbaire de chlorpromazine dans le glaucome absolu)

There can be quite a reaction when 1cc largactil combined with 1 cc novocaine 2% is injected as proposed.

Dr. van Oosterwijk-Kenya suggests either reducing the dose to 12,5mg. (only 0,5 cc. largactil 2,5%) or combining it with 40 mg. prednisone by mouth.

The reaction will be temporary anyway.

Viscoelastic:

Methylcellulose 2% can be bought cheaply from Shah and Shah 🍏.

28 Solar equipment

Solar energy

- For protection: any solar collector can be protected with wire netting. A group at the University of Twente (WOT), P.B. 217, 7500 AE Enschede, The Netherlands, made a description of a do-it-yourself-steriliser (according to themselves this design needs some improvements, but those interested in the subject can ask a copy).

Solar panels:

Solar panels seem very attractive as a means of obtaining cheap, permanent energy, which can be stored in a battery and used when and where needed.

There are some pitfalls however:

Basically it is not a push-button technology, unless you pay enormous sums for electrical circuitry, and hence it requires knowledge of how it works. This involves:

- polarity must be correct.
- subtracing has to be done for best results-this can be difficult when the whole village wants to see what you are doing.
- as a tiny piece of shadow will increase the electrical resistance of the photovoltaic cell tremendously this will cause a considerable drop in output.
- an approximate calculation of energy flows involved needs to be done.
- a diode preventing backflow from battery to the solar panel needs to be put into the circuit, if not done by the manufacturer.
- Ni-Cd-batteries can be seriously damaged by overcharging.
- lead-acid batteries can be seriously damaged by over-decharging.

So maybe the rechargeable batteries should have protecting electronics built into the batteries in order to serve best.

- a paradox is the sad fact that the higher the temperature of the panel, the lower the output will be, until at a certain point near 100 degree C it goes to zero, and the cells will be destroyed by heat. In sunny countries such a temperature is easily reached. One should therefore combine solar cells with a water-heater, i.e. the solar photo-voltaic cells need a cooling system or another protecting mechanism for best efficiency.
- **BST** offers a portable surgery light, rechargeable by solar power. It consists of a Tschudin-Hedi lamp, attached to a head band, two battery belts fitted with rechargeable Ni-Cd-batteries (weight 2.6 kg), one electronic charge-device, an Arco-Solar module type M 25 and waterproof casing for the generator and the converter.
The lamp can be used for 8 hours on one set of batteries, while the other set is loaded.
- Other companies sell other panels: ask for details and prices before ordering, ask also about capacity (charging time in your circumstances), warranty, protecting mechanisms, necessary equipment not included in the price, etc.

29 Training

Training for eye-surgery:

Eyes of animals can be used for training. Each kind has its own (dis)-advantages. In muslim countries one can use goat eyes, or rabbit's eyes, instead of pig's eyes.

Put the eyes in a jar with a little saline and expired broad-spectrum antibiotic. When kept like that in the fridge they can last 1 week. (for air-travel: keep them in your suitcase, not in your hand-luggage. It freezes in the luggage compartment, and it is difficult to explain to an air-hostess why your packet (of eyes!) has to stay in the fridge).

Practice boards:

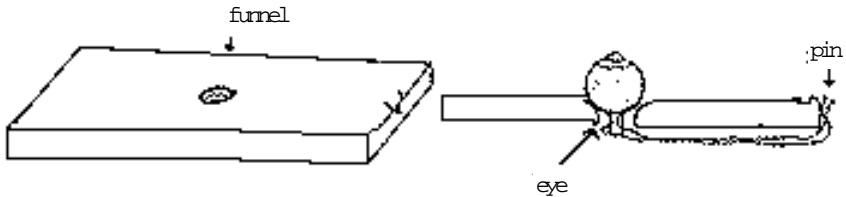

-Take a piece of polystyrene (white isolation material). Make a circle with a small coin, cut a funnel along the line with a Graefe knife or a no 11 knife, and it is ready. One stitch through the optic nerve holds the eye firmly in the funnel- the suture is passed through the funnel and fixed somewhere on the soft board with two pins.

Second method to make a practice board:

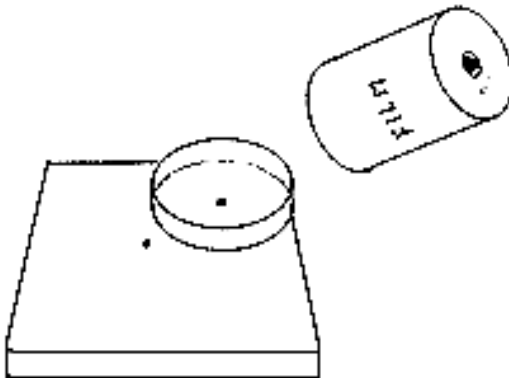

the lid of a 36 mm film box is nailed onto a piece of wood. The wood should be sufficiently heavy to prevent sliding of the eye-holder over the table. The bottom of the box is heated over an alcohol flame and after softening of the plastic one indents the bottom into a concave cup. The centre of the cup is perforated with an awl or a nail.

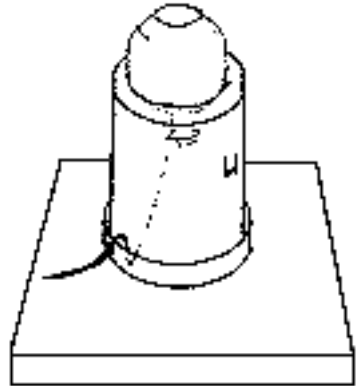

To fixate an eye to this holder one ties a suture around the optic nerve. The suture is then passed through the hole.

The box is fitted on the lid and the suture is clamped between the lid and the rim of the box.

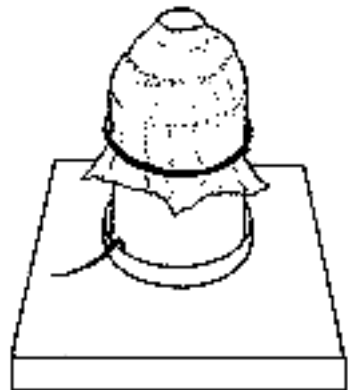
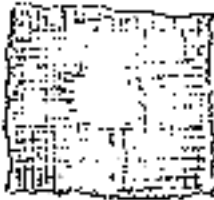

The intra-ocular tension should be imitated in any practicing section. This is done as follows: a hole is stabbed into a piece of gauze or linen, the size of ones thumb. The gauze is draped over the eye and fixed with a rubber band. By sliding the rubber band downwards over the cylinder of the box one may now regulate the intra-ocular pressure. This model serves for the demonstration of the syringe tonometer, too. For practicing the Graefe's incision the anterior chamber should have a normal depth. This is obtained by passing a 30 G needle obliquely through the cornea and injecting the anterior chamber with water. Only an oblique stab with a thin needle will prevent leakage after anterior chamber filling. The same technique can be used if a deep anterior chamber is required at the end of surgery.

For the first trial of Graefe's incision one can also use a small tomato or a grape.

30 Literature

- A Guide to Leprosy Control. Second edition. World Health Organization, Geneva. 🍏
- Aids in Africa. A manual for physicians. Peter Piot, Bila M. Kapita, Elizabeth N. Nguigi, Jonathan M. Mann, Robert Colebunders, Rudolph Wabitsch. World Health Organization, Geneva. ISBN 92 4 154435.
- WHO Expert Committee on Onchocerciasis. World Health Organization, Geneva.
- The provision of spectacles at low cost. World Health Organization. Geneva. ISBN 92 4 1561984 .
- Field Guide to the Detection and Control of Xerophthalmia. A. Sommer. World Health Organization.1982
- Guide to Trachoma Control. C.R. Dawson, B.R. Jones, M.L. Tarizzo. World Health Organization, Geneva.
- Management of Cataract in Primary Health Care Services. World Health Organization, Geneva.ISBN 92 4 1544082.
- Manual Trichiasis Surgery. W.H.O. 1993
- Strategies for the Prevention of Blindness in National Programmes. World Health Organization, Geneva.
- The Community Health Worker. World Health Organization, Geneva. ISBN 92 4 1560975
- The local small scale production of Eye Drops. W.H.O. 1992
- The Onchocerciasis Control Programme in West Afrika. E.M. Samba. World Health Organization, Geneva. ISBN 92 4 1561688.
- Prevention of Childhood Blindness. World Health Organization, Geneva. ISBN 92 4 1561513.
- A Handbook of Ophthalmology for Developing Countries. Geoffrey S. Bisley. Medical Publications Oxford. 1980
- A Village Struggles for Eye Health. Erika Sutter, Allen Foster, Victoria Francis. Macmillan Publishers LTD, London. ICEH £ 3.50 (also french edition) 1989. ISBN 0-333-51092-5
- Anaesthesia Notebook for Medical Auxiliaries. G. Kamm, T. Graf-Baumann. Springer-Verlag Berlin Heidelberg New York.
- Epidemiology and Statistics for the Ophthalmologist. Alfred Sommer. Oxford University Press, New York.
- Eye Care programmes in Developing Countries. Harjinder S. Chana. ISBN 82-990438-2-4. Norwegian Church Aid.
- Eye diseases in Hot Climates. John Sandford-Smith. Wright, London. ISBN 0 7236 0750 8. Low price edition ISBN 07506 0762 9.1986.
- Eye diseases in the Tropics. F.C. Rodger, foreword by A.W. Woodruff. Churchill Livingstone.
- Eye surgery in Hot Climates. John Sandford-Smith, David Hughes. F.A. Thorpe Limited, Leicester England.ISBN 0-7089-4499-x
- Ophthalmic Parasitology. B.H. Kean, M.D., Tsieh Sun, M.D., Robert M. Ellsworth, M.D. Igaku-Shoin, New York-Tokio.
- Eye Care in Developing Nations. Larry Schwab. Oxford Medical Publications. ISBN 0-19-261930-6

- Manual for the local production of eye drops. J. Taylor 1990 CBM 🍏
- World Blindness and its Prevention. Edited by the International Agency for the Prevention of Blindness (under the direction of Sir John Wilson). Medical Publications Oxford. ISBN 0 19 261249 2
- World Blindness and its Prevention. Volume 2. International Agency for the Prevention of Blindness. Oxford. ISBN 0 192614800
- Prevention of Blindness in Leprosy. Paul Courtright, Gordon J. Johnson. International Centre for Eye Health. 🍏
- Pratique de l'ophtalmologie avec des ressources limitées. Larry Schwab. Arnette. 1, rue de Lille, 75007 Paris. 1993 ISBN 2-7184-0646-1.

Other instruction materials:

- Prevention of Blindness Surgical. Video. £ 15.--. ICEH
- Community Eye Health Teaching Slide Series. TALC 🍏
- Ocular complications in Leprosy, Africa. M. Hogeweg. Series of 24 slides. NSL-INFOLEB, Wibautstraat 135, 1097 DN Amsterdam, the Netherlands.
- Journal Community Eye Health, 1997: 4 issues US\$70 International Centre for Eye Health. 🍏

Many books and teaching materials can be ordered from T.A.L.C for low prices.

31 Addresses

Addresses of organisations and companies.

If 🍏 follows a name in the text of the booklet, then the address is in this list. Addresses are listed in order of their index name.

- World Health Organisation books (Ch. 30)
Avenue Appia
1211 Geneva 27 Switzerland
Tel 791-21-11
Fax 791-07-46
- A and A Vision Optics AB compass for blind
P.O.Box 69 S-43222 Varberg,Sweden
Tel +46-340-75035 Fax +46-340-85744
- DU-AL Corporation cryoextractor
1912 Highway 142 East
Covington Georgia USA
Tel 770/784-9062 Fax 770/784-9366
- Bright cryo-fluid (Ch. 8)
St Margarets Way,Huntington
PE 18 6 EB England
Tel: (01480)454528 Fax: (01480)456031
- Appasamy Associates intra-ocular lens (Ch. 16)
20, SBI Officer's Colony
First Street,Arumbakkam,Madras
600106 India
Fax +91 44 4834721
- Aravind Eye Hospital intra-ocular lens (Ch. 16)
1,Anna Nagar,Madurai-625020 India
Fax +91 452 44980
- Florida Medical Manufacturing intra-ocular lens (Ch. 16)
Fax 18135720174 (USA)
- Shah & Shah intra-ocular lens (Ch. 16)
2,Russell Street,Calcutta-700071,India
Fax +91 1332295036
- ECHO medical supplies
Ullswater Crescent,Coulsdon
Surrey CR5 2HR,U.K.
Tel 081-660 2220 Fax 081-668 0751
- Tateno Chushashinkan Seisakusho, LTD metal capillary for cryoextractor
No. 911-1, Kokuwabara, Tatebayashi
Gumma, Japan
Tel 0276(72)1948

- Beckton Dickinson UK Limited
Between Towns Road,
Cowley
Oxford OX4 3LY
Tel (0865)748844
needles, 30 G (Ch. 7)
- Ophtec
P.O. Box 398
9700 AJ Groningen
The Netherlands
Tel +31 50 5251944 Fax +31 50 5254386
needle bending pliers, acetone box
- Hans Limburg
212 Golf Links
New Delhi 110 003
India
needle bending pliers
- Sutures Limited
Vauxhall Industrial Estate, Ruabon
Clwyd LL14 6 HA Wales, UK
Tel +44 978 823664 Fax +44 978 810669
8/0 nylon reel 100m
minimum 10 reels (Ch. 7)
- COIL
200 Bath Road, Slough Berkshire
SL1 4 DW England
Tel (0)1753 575011 Fax (0)1753 811359
optical industry
- Ensink Instruments
Jelissenkamp 62
8014 EX Zwolle, the Netherlands
Tel +31384657425 Fax +31384602235
slitlamp (Ch 4)
- Scan Optics
University of Adelaide Commerce Precinct
35 Stirling Street, Thebarton SA 5031
Australia
Tel: 61 8 234 9120 Fax: 61 8 234 9417
slitlamp (Ch. 4), light (4)
- A.Z.G.
Industriestrasse 23-33
D-22880 Wedel
Holstein Germany
solar energy (Ch. 29)
- Benelux Solar & Technical Systems bv
P.O. Box 120
4844 ZJ Terheijden
The Netherlands
Tel.: +31 (0)76 5934143 Fax.: +31 (0)76 5934138
solar energy (Ch. 29)
- International Centre for Eye Health
Institute of Ophthalmology
11-43 Bath Street
London EC1V 9EL U.K.
Tel 0171 6086909 Fax 0171 250 3207
teaching materials, courses,
Community Eye Health Journal (Ch. 30)

Index

	Page:
acetone	2, 58, 64
aftercataract	41
anesthesia, ketamine	51
anesthesia, pediatric	51
ball, rubber sponge	49
blade	15, 18
campimeter	13
cauter	33
chalk	67
cleaning instruments	67
cryoextractor	25
cyclocryoagulation	52
cyclothermocoagulation	52
drape facial	36
E chart	8
forceps	72
forceps, corneal	73
forceps, suture tying	73
fungi	12
hiv	61, 63
hypotony	48
intra-ocular lens, anterior chamber	41
intra-ocular pressure	4, 48
intra-ocular lens, posterior chamber	41
joint	71
ketamine	51
knife	14
Kuruvilla stand	50
lamp surgical	35
lock	72
loupe	34, 35
low vision	75
microscope	35
monsoon box	66
needle holder	14, 20, 25, 73
needle, micro surgical	20
no-touch-technique	53
ophthalmoscope,direct	6
ophthalmoscope,indirect	6, 7
painfull blind eye	76

paperclip	2
penlight	6, 7
phoropter, mini	6
povidone iodine	63, 66
practice board	78
rust	67
scissors, pair of	68
sheet operating	40
shield, eye	38
slitlamp	12
slitlamp, portable	11
solar energy	77
speculum	2
sphygometer	49
sponges	37
stainless steel wire	3
stand surgical	36
suture	20
suture rack	24
suture stainless steel	20, 42
tonometer, syringe type	4
tonometer, Goldman	66
training aids	78
viscoelastic	76
visual field	13
visual acuity	8

