



International Code of Conduct on the Distribution and Use of Pesticides

Guidelines on Management Options for Empty Pesticide Containers



**World Health
Organization**



FOOD AND AGRICULTURE ORGANIZATION
OF THE UNITED NATIONS

MAY 2008

This publication was developed in the IOMC context. The contents do not necessarily reflect the views or stated policies of individual IOMC Participating Organizations.

The Inter-Organization Programme for the Sound Management of Chemicals (IOMC) was established in 1995 following recommendations made by the 1992 UN Conference on Environment and Development to strengthen co-operation and increase international co-ordination in the field of chemical safety. The participating organizations are FAO, ILO, OECD, UNEP, UNIDO, UNITAR and WHO. The World Bank and UNDP are observers. The purpose of the IOMC is to promote co-ordination of the policies and activities pursued by the Participating Organizations, jointly or separately, to achieve the sound management of chemicals in relation to human health and the environment.

Table of contents

Abbreviations.....	1
Definitions	2
1 Introduction.....	3
1.1 Pesticide containers	3
1.2 Intrinsic value of containers.....	6
1.3 Reuse of one-way containers	6
1.4 The waste management hierarchy.....	6
1.5 Cleaning containers.....	8
1.6 Disposal at the place of use	16
1.7 Stakeholder involvement	16
2 Assessment of the nature and scale of the issue	17
2.1 Other agricultural packaging	19
3 Mechanisms for developing a container management scheme	19
3.1 Legal basis	19
3.2 Economics and incentives.....	21
3.3 Infrastructure and logistics	22
3.4 Countries with low pesticide use	26
4 Farmers and other uses of pesticides	26
5 Pre-processing	27
5.1 Volume reduction	27
5.2 Material segregation	28
6 Recycling and Disposal.....	28
6.1 Recycling into new products.....	28
6.2 Resource Recovery	30
6.3 Disposal	31
7 Examples of schemes	31
7.1 Australia.....	32
7.2 Belgium.....	32
7.3 Brazil.....	33
7.4 Canada	34
7.5 Chile.....	35
7.6 France.....	36
7.7 Guatemala	37
7.8 Germany.....	38
7.9 Hungary.....	39
7.10 USA.....	39
7.11 Performance of container management schemes around the world.....	40
8 References and further information	42

Abbreviations

ACRC	Ag Container Recycling Council
ADR	European agreement concerning the international transport of dangerous goods by road
AFIPA	National Association of Manufacturers and Importers of Crop Protection Products
AGREQUIMA	Agrochemical Trade Association
ALGA	Australian Local Government Association
ANDEF	Associação Nacional De Defesa Vegetal
Avcare	National Association fro Crop Production and Animal Health
CWFG	Chemistry Business Promotion Corporation
ECPA	European Crop Protection Association
FAO	Food and Agriculture Organization of the United Nations
GEF	Global Environment Facility of the United Nations
HDPE	High Density Polyethylene
inpEV	National Institute for Processing Empty Containers
IPM	Integrated Pest Management
IVA	Crop Protection, Pest Control and Fertilizer Association
IWRS	Industry Waste Reduction Scheme
MoU	Memorandum of Understanding
NFF	National Farmers' Federation
NGO	Non Governmental Organization
OECD	Organization for Economic Cooperation and Development
RIGK	Recovery of Industrial and Commercial Plastic Packaging
STAP	Scientific and Technical Advisory Panel of the GEF
UIPP	Union des Industries de la Protection des Plantes
VMDA	Veterinary Manufacturers and Distributors Association
WHO	World Health Organization

Definitions

One-way pesticide container. Containers that should not be reused or refilled once the contents have been deployed.

Primary packaging. Packaging that is in direct contact with the pesticide.

Secondary packaging. Packaging that protects the primary packaging. Secondary packaging does not normally come into contact with the pesticide.

Rinsate. The contaminated rinse liquid once it has been used to rinse a container.

Guidelines on Management Options for Empty Pesticide Containers

1 Introduction

This guideline provides advice on the management of one-way pesticide containers following the deployment of their contents. Unless empty pesticide containers are managed correctly, they are hazardous to both mankind and the environment. There is a danger that empty containers could be reused for storing food and water, which could result in pesticide poisonings. Containers abandoned in the environment can lead to pesticide pollution in soil and groundwater. A container management scheme can minimize these risks and is part of the “life-cycle concept” as addressed in the *International Code of Conduct on the Distribution and Use of Pesticides* [1].

A container management scheme should ensure that:

- the containers are decontaminated directly following the use of their contents;
- inappropriate use of the empty containers is prevented; and
- it is easy for users to return their empty containers to the scheme.

The safety of pesticide users and the public is of paramount importance when designing a container management scheme.

Successful container management schemes around the world have been achieved only with the engagement and support of all stakeholders in the supply chain for pesticides. These stakeholders include government bodies, manufacturers, users, distributors and suppliers, recyclers and disposers, NGOs and trade unions. This guideline identifies how each of these stakeholders can contribute to a container management scheme. The guideline considers the role of manufacturers in the design of the containers and the formulation of the product as well as their responsibility for product stewardship.

The safe and environmentally sound management of containers at the end of their life is an external cost to the marketing and use of pesticide products. As such, the container management scheme should bear these costs. The scheme will require adequate funding to support all its operations and the environmental management of the empty containers. It is the choice of the government how the scheme should be structured and funded. Options include general taxation, levies on the manufacturers and importers, deposits, or fees. These options are discussed in more detail in section 3.2.1.

The issue of legacy stockpiles of old containers contaminated with pesticide residues is addressed in FAO’s *Guideline on the Disposal of bulk quantities of obsolete pesticides in developing countries* [2], of which a revised version is due to be published to avoid any duplication with this guideline.

1.1 Pesticide containers

The design of a pesticide container is important. A well-designed container can help to:

- minimize the risks of leakage during transport and storage;

- minimize exposure to users; and
- minimize the burden on the environment at the end of the container's life.

Likewise, a poorly designed container is hazardous. A country should therefore regulate the design of the container as well as the pesticide formulation when it registers a pesticide product. The principal criteria for a well-designed container are:

- to contain the product and prevent its contents escaping during storage and transport;
- to protect the pesticide product from impairment due to the conditions under which it is distributed and stored;
- to allow the product to be transferred into its application system without endangering the health of users or the environment;
- to minimize the burden on the environment from the management of the container, once the contents have been deployed.

In assessing a container, the registration authorities should consider whether it meets the criteria for storage, transportation and use. Provided it satisfies these criteria, the registration authorities should then consider the criteria for minimizing the environmental burden of the recycling or disposal of the empty container at the end of its life.

Design criteria for storage, transport and use

A container can satisfy the criteria for safe storage, transport and use when:

- it complies with the UN packaging codes;
- it is constructed from materials that are inert, that are impermeable to the contents, and to which pesticides and rinsing liquids do not adhere;
- it is sufficiently robust to withstand the hazards of distribution and storage;
- it is liquid tight and has a resealable cap;
- it is easy to handle by users;
- it pours accurately and smoothly without dripping or gugging;
- it can be completely emptied by avoiding features that trap the contents;
- it is labelled appropriately;
- it has an easy method to identify the amount of pesticide remaining in the container, e.g. translucent container walls; and
- it is easy to rinse.

A container that can be emptied fully and easily rinsed has an economic benefit to the user so that the entire contents are available for use against its target pest. An empty rinsed container also represents a lower hazard to the public and environment.

Design criteria for minimizing the environmental burden of the recycling or disposal of the empty container

Provided that the safety criteria have been satisfied, the environmental burden of the recycling or disposal of the empty container should be assessed. Minimizing the ratio of the weight of the empty container to that of a full one will reduce the overall quantity of material to be recycled or disposed of

at the end of the container's life. The choice of the materials from which the container is constructed has a bearing on its recyclability. Ideally containers should be made from a single type of material. This avoids the need for expensive processes to break it down into its constituent components during the recycling process. This is particularly an issue with a container made from more than one type of plastic.

Labelling

The container label plays a vital role in communicating information about the pesticide, its hazards, safety information and its use. International regulations, such as the *European agreement concerning the international transport of dangerous goods by road* (ADR) [3], FAO codes and the newly adopted *Globally Harmonized Systems of Classification and Labelling of Chemicals* (GHS) [4], set out standards for the design and content of the label. Containers should also have labels with information about how they should be cleaned and disposed of following their use.

As part of a country's pesticide registration process, the standard of containers allowed to enter the market can be strictly controlled to ensure that these design and labelling requirements are met.

1.1.1 Alternatives to one-way containers

The most common form of packaging used for pesticides is the one-way container, which needs to be managed after the deployment of its contents. However, there are alternative container designs that have been developed to avoid the necessity of recycling or disposing of the empty containers, including reusable/refillable containers and water soluble containers.

Refillable Containers

Refillable containers have been developed for pesticide applications where there is a large and regular demand and the products are used relatively close to where the containers can be refilled. Refillable containers are therefore only appropriate in a very few cases. The potential advantage of using reusable/refillable containers is that they avoid the manufacturing cost of a new container and the cost of their disposal after each deployment. There are issues that need to be considered with reusable containers including:

- the long-term permeation of the pesticide into the container material;
- the long term integrity of the container and label;
- build-up of residues after repeated use and refilling;
- separation or crystallization; and
- homogeneity of the residues and the product to be refilled.

Refillable containers should only be refilled with the same formulated pesticide product to avoid the risks of cross-contamination.

Water Soluble Packs

Soluble packaging is an option for pesticides that are diluted with water before application. The soluble sacks are put directly into the spray tank where they dissolve and release their contents. There are two main advantages:

- there is no operator exposure to the contents as the packs do not require opening; and
- there is no contaminated container to be recycled or disposed of.

The soluble container should be considered an integral component of the formulation. Soluble packs require waterproof secondary packaging to protect them from damage during their storage and distribution.

Pesticide regulations should encourage innovation in package design that improves public safety and reduces the burden on the environment.

1.2 Intrinsic value of containers

Empty containers have a value in some economies for the storage of water and food, or for recycling into cookware and tools. The cost of a new 200 litre steel drum is equivalent to one month's salary for a store keeper in some regions. Without adequate control, there is the danger that pesticide containers are used for the above-mentioned purposes, thus leading to public health issues due to contaminated food and water supplies. Pesticide containers, however well cleaned, are not appropriate for the storage of water and comestibles. The container management scheme should be designed with safeguards to ensure that pesticide containers are not used in this way. Appropriate safeguards should include:

- instructions to users to immediately clean the container of its contents following use and then to physically damage it to render it unusable. Cleaning procedures such as triple rinsing are discussed in section 1.5.5. Puncturing or cutting containers are appropriate means of preventing their reuse.
- education and communications programmes, aimed at raising awareness of the dangers of using pesticide containers for storage of food and water. Examples of publicity materials are included in section 3.3.3.

1.3 Reuse of one-way containers

One-way pesticide containers should not be reused or refilled once the contents have been deployed because of the potential for contamination. The only circumstance when a container may be refilled is if it is refilled with an identical product that is being transferred from a damaged container.

1.4 The waste management hierarchy

The waste management hierarchy sets out an order of precedence for the selection of the most favourable waste management option. The most preferred options are those that have either no impact or minimal negative impact on the environment, while the least preferred ones have a significant negative impact. Many countries enshrine the hierarchy in their environmental legislation. The hierarchy has been used in this guideline in the selection of recommended solutions for containers. The hierarchy is shown in Figure 1 below.

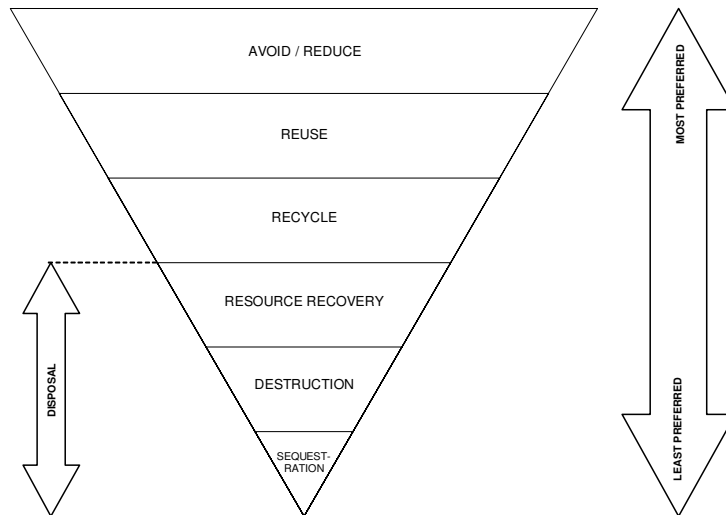

Figure 1: Waste management hierarchy

The following examples, moving from most preferred to least preferred options, show how the hierarchy functions.

Avoid / Reduce

Using fewer pesticides through adopting practices such as Integrated Pest Management (IPM) will reduce the quantity of waste containers. It also reduces the release of pesticides into the environment and has economic benefits to users. Using water soluble containers avoids generating contaminated containers.

Reuse

The use of closed-loop refillable containers allows the container to be used many times before it reaches the end of its life, when it has to be recycled or disposed of. Reusable containers are preferred because they avoid the environmental costs of the manufacture and disposal of several one-way containers. Reusable closed-loop containers have only limited applications, as explained in section 1.1.1.

Recycle

Recycling is the reprocessing of the materials from which the container was constructed into other products. Recycling does generate some environmental costs, such as energy use in reprocessing the materials, but there is no loss of the raw material. It is preferred over the options where the material is destroyed or unavailable for use.

Resource recovery

Use of the combustible components of the container materials as fuel in a cement kiln or power station is considered resource recovery. The container materials are destroyed but the energy is recovered and used in the process.

Destruction

High temperature incineration destroys containers and their pesticide contaminants, converting their chemical components into less hazardous by-products.

Sequestration

Landfill or permanent storage of the containers are examples of sequestration. The containers still exist but their hazards are prevented from impacting public health or the environment. Sequestration can use up scarce land, making it unusable for agriculture.

1.5 Cleaning containers

1.5.1 Advantages of cleaning containers

The cleaning of containers has many advantages, therefore it should be encouraged.

The economic advantages are:

- rinsing saves money. An empty container allowed to drip into the spray tank could still contain 2 percent of its original contents. By rinsing and adding the rinsate to the tank, none of the pesticide is wasted;
- recycling or disposal of a properly rinsed container should be less expensive. The residual pesticide contamination will be sufficiently low (see sections 1.5.9 and 1.5.10) for it to be classified as non-hazardous waste.

The environmental advantages are:

- a properly rinsed container minimizes the risks of contamination to soil, surface water and ground water;
- rinsing the container immediately after emptying it reduces the chances of exposure to users, the wider public and animals;
- properly rinsed containers may be recycled into other products rather than requiring their destruction as hazardous waste.

Cleaning containers is fundamental to any management scheme for one-way containers as it reduces the hazards associated with the subsequent processes and risks to public health and the environment.

1.5.2 When should containers be cleaned

Cleaning should be undertaken immediately following emptying the container such that all of the product may be used for its intended purpose and any residual contamination is not allowed to adhere to the internal surfaces of the container. Pesticide residues that are allowed to harden and congeal on the surfaces of the container or its cap are much more difficult to remove. They often require physical abrasion and much more rinsing liquid. Rinsing immediately when the pesticides are still liquid is quick and easy.

1.5.3 Legal basis for cleaning containers

A country cannot rely on users alone to clean containers. Although the majority of users may clean their containers because it makes economic and environmental sense, there will be a proportion of users that will not clean them. To persuade this group to clean their containers, it should be made mandatory under pesticide regulations. The legal definition of an “empty container” should state that it has to be properly rinsed. A container that has not been properly rinsed should remain classified as hazardous.

1.5.4 Cleaning methodologies

The cleaning methodology to be used depends on the physical and chemical characteristics of the pesticide. In all cases instructions for cleaning the container should be included in the product label and product safety data sheets. Cleaning methodologies are shown in Table 1 below.

Formulation	Cleaning methodology
Emulsifiable concentrates	Rinsing with water using the manual triple rinsing technique, pressure rinsing or integrated rinsing
Water soluble products	
Water soluble solids	
Oil and solvent based products	Rinsing with solvent

Table 1: Cleaning methodologies

It is important to note that an inappropriately selected cleaning methodology will be at best ineffective and at worst dangerous. For example some pesticide formulations are water reactive and, if the containers were triple rinsed, there could be a violent reaction.

The majority of one-way containers available on the market are appropriate for rinsing with water. For the sake of clarity, this guideline focuses on water rinsing as the cleaning methodology.

It is extremely important that the effective rinsing of containers takes place as soon as possible after deployment of the pesticide. In most cases this will occur at the place of deployment, e.g., on the farm. Notwithstanding how an empty container is recovered, it must be properly rinsed. This underpins all subsequent activities. The correct practice for rinsing requires the user to:

- rinse the containers immediately after emptying them;
- add the rinsate to the spray tank as part of the make-up solution.

This allows for effective removal of pesticide residues. In addition to being good agricultural practice, it makes good economic sense by ensuring that users are able to use all of the pesticide. If the rinsate cannot be added to the application equipment of the mixing tank, it may be stored for later use or disposal. Disposal should always be in accordance with FAO and WHO guidelines and national and international laws and regulations.

There are three standard rinsing options:

- triple rinsing;
- pressure rinsing;
- integrated pressure rinsing.

1.5.5 Triple rinsing

Triple rinsing is the method to use in the absence of *ad hoc* mechanical rinsing equipment. It is likely to be the most practical option in developing economies. It can be used to clean all sizes of containers but the technique is slightly different for small containers that can be shaken by hand, and large containers that are too big to shake. Examples of the rinsing instructions are shown below.



(Copyrighted by Bayer CropSciences)

Figure 2: Examples of triple rinsing

For containers small enough to shake:

- empty the remaining contents into the application equipment or a mix tank and drain for at least 30 seconds after the flow begins to drip;
- fill the container ¼ full with clean water;
- securely re-close the cap;
- shake, rotate and invert the container so that the water reaches all the inside surfaces;
 - either add the rinsate to the application equipment or the mix tank; or
 - store it for later use or disposal;
- allow the container to drain for 30 seconds after the flow begins to drip;
- the procedure should be repeated at least twice more until the container appears clean.

For containers that are too large to shake:

- empty remaining contents into the application equipment or a mix tank;
- fill the container ¼ full with water;
- replace and tighten closures;
- tip container on its side and roll it back and forth, ensuring at least one complete revolution, for 30 seconds;

- stand the container on its end and tip it back and forth several times;
- turn the container over onto its other end and tip it back and forth several times;
- empty the rinsate into application equipment or a mix tank or store rinsate for later use or disposal. Repeat this procedure at twice more until the container appears clean.

1.5.6 Pressure rinsing

Pressure rinsing equipment uses water under pressure (typically three bar) in the form of a static or rotating spray jet and valve. The jets of water hit the internal surfaces of the container removing and dissolving the pesticide residues. Some pressure rinsing equipment includes a sharp device that penetrates the container walls for rinsing purposes, thereby offering the additional advantage of making the container unusable for storage. These devices should be used in accordance with the manufacturers' instructions to avoid injury to the operator. Examples of pressure rinsing devices are shown in Figure 3 and Figure 4 below.



(Copyrighted by the North Dakota State University Agriculture and University Extension [5])



Copyrighted by the University of Florida, Institute of Food and Agricultural Sciences (UF/IFAS) [6] for the people of the State of Florida.

Figure 3: Examples of pressure rinsing devices

The procedure for pressure rinsing small containers is the following:

- put on the personal protective equipment listed on the product label;
- install pressure-rinse nozzle on hose connected to a water supply capable of delivering three bar of water pressure;
- allow formulation to drip-drain from its container into the sprayer's tank for at least 30 seconds;
- firmly press the pressure-rinse nozzle tip into the side or bottom of the pesticide container until the probe is inserted and seated, then turn on and rinse the container for at least 30 seconds with it draining into the sprayer's tank. During the rinsing, rock and rotate the nozzle so that the water jets reach all internal surfaces of the container. Make sure hollow handles are properly rinsed;

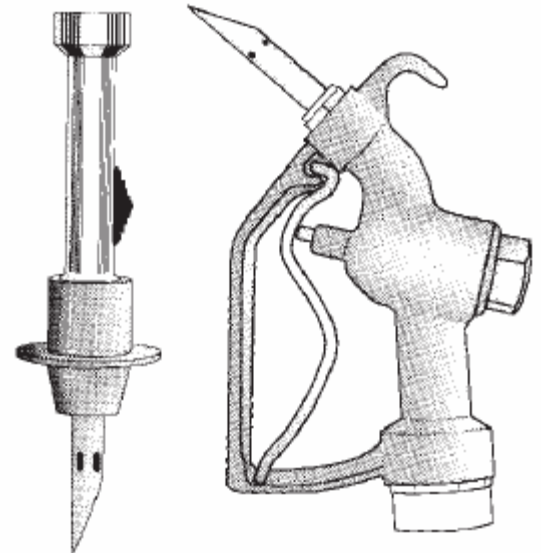

(Copyrighted by the North Dakota State University Agriculture)

Figure 4: Pressure rinsing tools

- allow the container to drip-drain for at least 30 seconds;
- rinse the caps by placing in a bucket of water for 3 minutes. Screw the rinsed caps back onto the container and add the water to the spray tank

NOTE: Use "rocking", twisting or "wobbling" motion to make sure spray hits bottom of container; or pierce side of container instead of bottom.

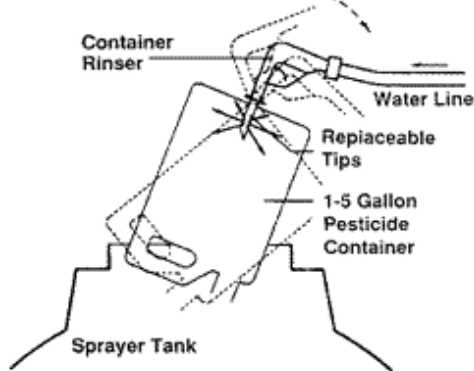

(Copyrighted by the North Dakota State University Agriculture and University Extension)



(Copyrighted by BayerCropScience)

Figure 5: Pressure rinsing in action

For larger containers that are too heavy to lift above the spray tank, for example 200 litre drums, a suction/rinse probe can be used with the container standing upright. A diagram of a probe is shown in Figure 6 below. The procedure for rinsing large containers is the following:

- using the probe suck the contents into the spray tank. Tilt the drum slightly so the remaining contents gather in a corner at the bottom and suck these into spray tank;
- turn on the rinsing nozzles while sucking the rinsate into the mixing tank. Rinse for 3 to 5 minutes;
- turn the rinsing nozzles off and continue to suck the rinsate into the spray tank. The drum can be tilted to enable all the rinsate to be sucked into the spray tank.

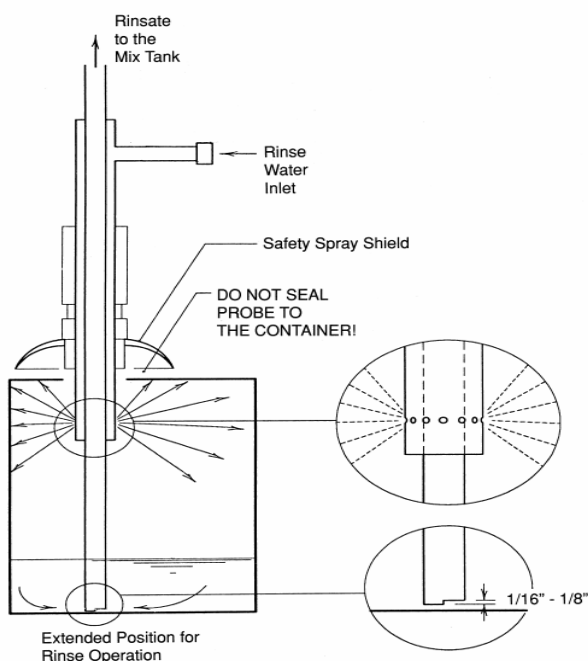

(Copyrighted by the North Dakota State University Agriculture and University Extension)

Figure 6: Suction rinse probe for large containers

1.5.7 Integrated rinsing

Integrated rinsing technology incorporates the rinsing process directly into large scale tractor-mounted spraying equipment. Wherever possible, integrated rinsing equipment should be used. Integrated rinsing is the most efficient method of rinsing containers and provides a high level of operator safety. It is also quicker than both triple rinsing and pressure rinsing. Integrated rinsing devices rinse by using water under pressure (of typically three to five bar). A static nozzle with a valve is normally built into the induction hopper of the sprayer. The water pressure cleans the container until no residues are visible (typically requiring up to 30 seconds and 15 litres of water). The rinsate is then automatically added to the spray liquid.

Integrated rinsing devices can be built into a closed chemical transfer system and can therefore provide both efficient rinsing and even greater operator safety. This avoids spillage, which may expose the operator to unnecessary risk.



(Copyrighted by BayerCropScience)



(Copyrighted by BayerCropScience)

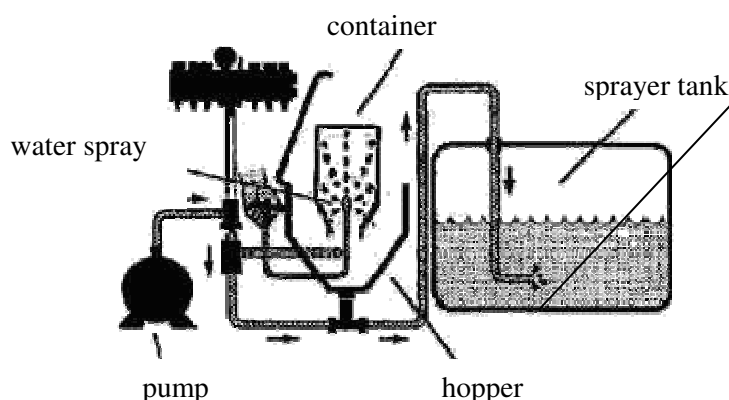

(Copyrighted by Casafe: <http://www.casafe.org/>)

Figure 7: Integrated rinsing equipment

Closures can be rinsed by placing them in the induction hopper. With triple rinsing, they are cleaned by the shaking process. In addition, the manufacturer's instructions should be followed when using any rinsing equipment.

Once a container has been rinsed, it should be inspected to ensure that all residues have been removed and then physically punctured or cut to render it unusable. The empty containers are then ready to be consigned to the container management scheme.

Whatever the selected method of rinsing, the rinsate should ideally be added directly to the spray solution. In the case where the next application is planned in the near future and provided that the pesticide formulation has not exceeded its expiry date, the rinsate can be stored for this future use. The storage containers should be labelled appropriately. Where there is no future need or the formulation cannot be guaranteed to be within specification, the rinsate should be legally disposed of in accordance with the FAO guidelines.

1.5.8 Solvent rinsing

For pesticides that are formulated in a solvent or oil and are not water soluble or dispersible, the rinsing process has to use a solvent as the rinsing medium. Solvent rinsates may not be suitable for adding to the formulated product for application, in which case they have to be treated as pesticide waste and be disposed of in an environmentally sound manner.

Automated solvent rinsing and drum crushing

Automated equipment is available for rinsing containers that had contained oil and solvent based pesticides. Such equipment has been used effectively to clean and crush the empty containers resulting from campaigns to control Desert Locusts. The process steps are:

- empty container is placed inside the unit, and the doors sealed;
- the drums are punctured by the solvent sprayers;
- solvent is sprayed inside the drum;
- solvent is extracted from the drum;
- clean drum is crushed;
- the solvent is reused until pesticide concentrations build up;
- the contaminated solvent is disposed of as pesticide waste.

Figures 8 below shows solvent washing and crushing equipment.



(Copyrighted by FAO)

Figure 8: Automated solvent washing and crushing equipment

1.5.9 Performance of rinsing techniques

Tests have been undertaken to demonstrate the effectiveness of triple rinsing as described above. Table 2 below shows the result of an experiment to determine the quantity of an active ingredient remaining in a container at each of the stages in triple rinsing.

Active ingredient in 1 oz (28g) of liquid remaining in a 5 gallon (22.5L) container		
Rinsing stage	Pesticide residue	Percentage remaining
After draining	14.2 g	100.0%
After 1st rinse	0.2 g	1.4 %
After 2nd rinse	0.003 g	0.021 %
After 3rd rinse	0.00005 g	0.00035%

Table 2: Rinsing statistics

(Source: Pest Management Principles for the Wisconsin Farmer)

1.5.10 Waste classification for rinsed containers

Countries should address the issue of waste classification of rinsed containers either as “hazardous waste” or “non-hazardous waste”. The decision can make a significant difference to the costs and administrative burden of the container management scheme. In Europe, if empty containers are classified as “hazardous waste” their transportation is tightly controlled and subject to regulatory charges. International transboundary movements would likewise have to be subject to the procedures of the Basel Convention [7]. Recycling and disposal options are more costly and fewer for containers classified as hazardous waste.

In Germany the cost differential between managing empty containers as hazardous and non-hazardous has been estimated at €0.60 per kilogram of empty container [18].

Cleaned pesticide containers are classified in many European and North American countries as “non-hazardous” waste. However there are exceptions such as Spain, France and Ireland where they are classified as “hazardous”.

The European Waste Catalogue¹ [9] provides guidance on classification of “packaging containing residues of or contaminated by dangerous substances”. Where the concentration of the highly hazardous component is less than 0.1 percent, the packaging is classified as “non-hazardous”. Studies undertaken in Canada have analysed the residual contamination in triple rinsed containers from 40 different highly hazardous pesticide products. The studies have investigated the contamination that adheres to the container surface and has permeated into the container materials. These studies show that the overall concentration in the container falls below 0.1 percent (source CropLife International).

FAO/WHO recommend that countries should classify properly rinsed containers that have been inspected as non-hazardous.

1.5.11 Comparison of rinsing techniques

Triple rinsing and pressure rinsing, when undertaken to the standards set out in these guidelines are able to clean containers so that the containers should be classified as non-hazardous waste. Table 3 below shows the principal differences between the two procedures.

¹ European Waste Catalogue number 15 01 10*

Features	Pressure Rinsing	Triple Rinsing
Number of Steps	8	17
Time Spent per Container	1 - 2 min.	4 - 9 min.
Container Types Rinsed	All	All
Special Equipment Needed Rinse	Nozzle/high pressure water	None

Table 3: Comparison of triple and pressure rinsing

Cleaning a container by triple rinsing involves twice as many steps and takes about four times as long as pressure rinsing. However it does not need any special equipment. Triple rinsing is likely to be the preferred technique where pesticide usage is low and there is limited availability of special equipment. Pressure rinsing is likely to be the preferred option in locations where there is intensive agriculture.

1.6 Disposal at the place of use

FAO/WHO recommend that the practice of disposal of pesticide packaging at the place of use by burying or burning be prohibited.

1.6.1 Burning of containers

Burning plastics and pesticides in an uncontrolled fire will not destroy the hazardous components completely and may generate environmentally persistent toxic emissions. The only thermal processes that are able to destroy plastics and pesticides are licensed high temperature incinerators and cement kilns with effective emission controls. Pesticide products should never be burnt at the farm or any other place of use. Countries should apply the precautionary principle and should regulate to prevent such burning of all primary packaging, whether cleaned or not.

1.6.2 Burial of containers

Burying rinsed pesticide containers at the place of use is not an ideal solution. It potentially uses up scarce land and can be a danger to animals. Plastic containers are highly stable and do not biodegrade, so, if buried, they will remain intact indefinitely. Burying containers is not easy because the void space inside them and their low density cause them to rise gradually to the surface of the soil. As such, burying at the place of use is not a viable solution. Countries should regulate against burial of all containers and develop a container management scheme that makes it easy for all users to return empty containers.

1.6.3 Disposal of Secondary packaging

Clean secondary packaging, such as pallets and outer cardboard cartons, which has not come into direct contact with pesticides can be assumed to be uncontaminated. This can be disposed of as municipal waste. Material recycling and energy recovery are the disposal routes of choice but if neither option is available, the secondary packaging may be disposed of as municipal waste.

1.7 Stakeholder involvement

For a successful container management scheme it is important to engage and involve all stakeholders. These include:

- governments and their agencies whose responsibility it is to set up and to regulate the legal framework for pesticide registration, pesticide use and disposal of waste materials, and to determine the mechanisms for funding the scheme;
- manufacturers, importers and suppliers who are responsible for compliance with pesticide and waste regulations, good practice in product and container design, product stewardship throughout the supply chain and who, in many cases, fund and manage the container management scheme;
- users, whose responsibility it is to manage and use pesticide products in a safe, legal and responsible way, including the return of the empty containers for appropriate recycling/disposal;
- NGOs, agricultural colleges and schools, extension services, farmer cooperatives and associations who are well placed to raise awareness of good practice in pesticide use, and in some cases to run container management schemes;
- waste management and recycling organizations.

When a country wishes to establish a container management scheme, it should consult widely and involve these stakeholders in the development of the scheme. Establishing a steering committee and stakeholder forum early in the process should be a priority. Further guidance can be found in FAO's Code of Conduct [1] and FAO's Country Guidelines [19].

2 Assessment of the nature and scale of the issue

To evaluate the options for developing a container management scheme, the first step is to assess the types and quantities of the pesticide containers that it will have to manage. The Stakeholder Forum should be able to provide the information necessary for making the assessment.

The assessment should start with a review of pesticide information that is available within existing registration, customs records and other data collection systems. Where necessary, this can be augmented with surveys of the pesticide market. The objective of the review is to assess the geographic distribution, types and quantities of containers that are supplied to users. Manufacturers, importers, formulators, repackers and distributors will be able to provide this information. Customs authorities will be able to provide information on imported pesticides. User associations may be able to provide information about pesticide usage patterns.

Understanding the way that the supply chain functions is important, particularly when determining the opportunities to use it as a potential reverse distribution mechanism for collecting empty containers. An example of a supply chain is shown in Figure 9 below.

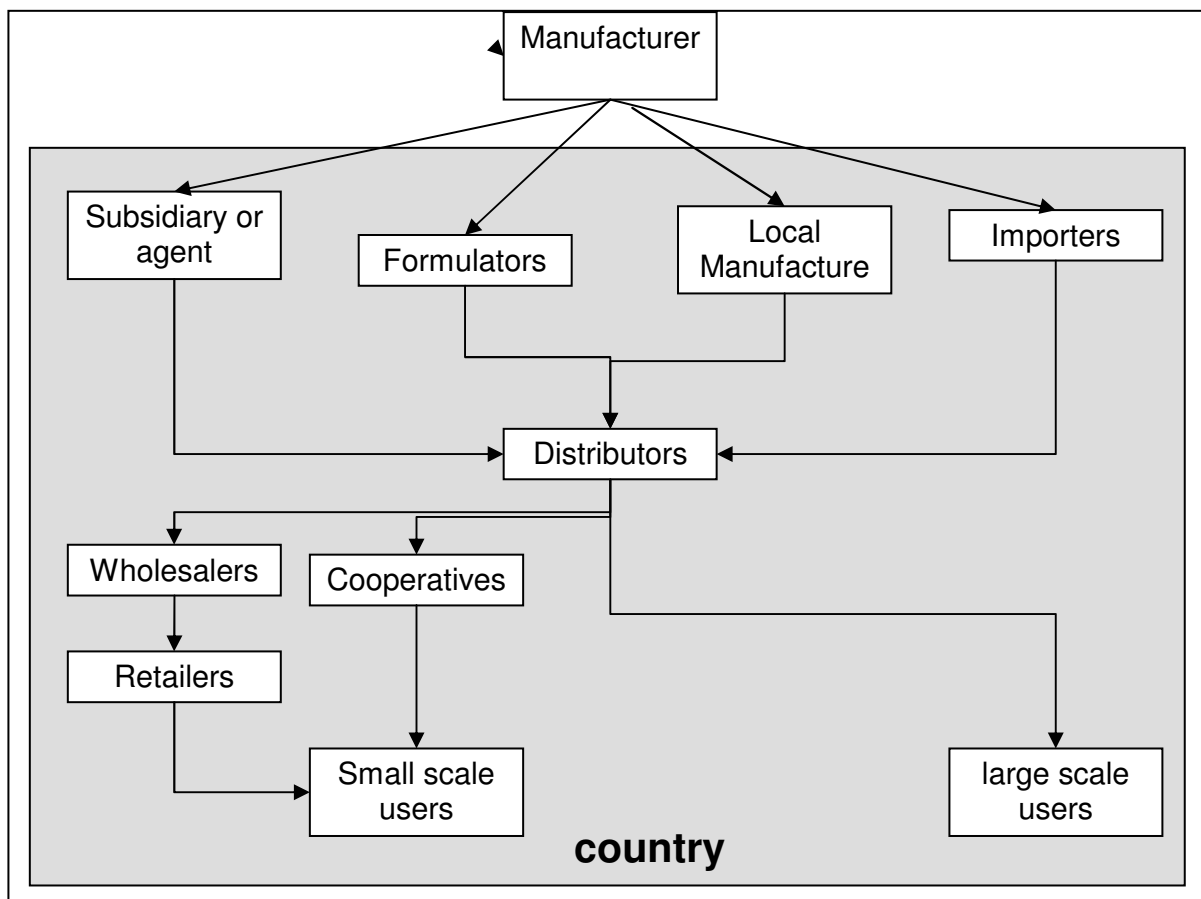

Figure 9: Sample supply chain

In evaluating the supply chain, it is important to explore all the potential paths that a pesticide product could take before it arrives at a user. In some economies, it could also be necessary to consider those pesticides that are distributed illegally. In such cases, methods for their regulation and control should be developed.

At the end of the survey the country should attempt to quantify the various packaging materials put onto the market as set out in Figure 10 below.

Type of container	Material	Quantity/kilos)
Metal	Steel	
	Aluminium	
	Total metal	
Rigid plastic	High-density polyethylene	
	COEX	
	PET	
	Polypropylene	
	Total rigid plastic	
Flexible bags	Polyethylene	
	Metallized	
	Paper with interior lining	
	Total flexible bags	
Boxes	Cardboard	

Figure 10: Template for recording annual quantities of packaging materials

The distribution of pesticides in the agriculture sector is a function of geography, in terms of land-use throughout the country, and it is related to the seasons during which they are used. In the health sector, geography is a function of the spatial and temporal distribution of vector-borne diseases. In assessing the needs of a container management scheme, it is important to take into account the periods during which the empty containers need to be collected from the users. The assessment should provide an indication of the cyclicity and peaks in demand, the distribution of the sizes and types of container, the quantities for each material, and their geographic distribution.

The output of this assessment will be a specification for the demands that the container management scheme has to meet. The recommended process steps to establish a full-scale scheme are:

- undertake a feasibility study, and if it proves viable, proceed to the next step;
- undertake pilot projects in the different areas of the country with different user groups. If this is successful, proceed to the next step;
- develop a full-scale scheme.

2.1 Other agricultural packaging

This guideline is focused on one-way pesticide containers that are required to be collected from users or delivered by users to collection points. The users are also likely to have packing materials from other agricultural products such as fertilizer sacks and veterinary products that require disposal or recovery. Some agricultural techniques use plastic sheeting as a mulch to protect soil and plants. At the end of the growing season, this requires disposal. These materials require similar recycling and disposal technologies to pesticide containers.

Economies of scale and logistical efficiencies may make it worthwhile providing a combined management scheme for this other packaging and plastic waste along with the empty containers. The combined scheme is likely to have lower costs per tonne collected.

3 Mechanisms for developing a container management scheme

In determining the structure of a container management scheme consideration needs to be given to its legal basis; how it is funded and incentivized; and the practicalities of its infrastructure and logistics.

3.1 Legal basis

There are two models for container management schemes that have been employed to date, the voluntary model and the legally mandatory model.

3.1.1 Voluntary scheme

The voluntary model is a scheme that foresees an organization to set up a scheme without the support of a legal framework from the government. Organizations that have set up voluntary schemes include the trade associations of pesticide manufacturers, and NGOs. Pesticide trade associations have established many voluntary schemes around the world, as a component of a product stewardship

programme. NGOs have initiated pilot collections schemes that have then developed into fully-fledged schemes.

Voluntary schemes can be successful, particularly where all the suppliers within a country participate in the trade association and contribute to the scheme. However in some markets pesticides are also supplied by manufacturers that do not participate in the trade associations and do not wish to contribute to the container management scheme. The collection of their containers is in effect funded by their competitors. In the long run this is unsustainable. Companies that contribute to the scheme are disadvantaged and eventually will be forced to pull out of the scheme.

Sustainable collection schemes will only be achievable in the long term where there is a secure source of funds. This can be achieved with a scheme that is legally mandated.

3.1.2 Legally Mandatory scheme

Legally mandatory schemes are those that are required to be put in place under a country's pesticide regulations. Generally, as part of a pesticides registration and authorization for use, there is a requirement for users to participate in the scheme.

If the country chooses the legally mandatory scheme, a sustainable funding mechanism can be established in the regulations. Where levies are imposed on suppliers of pesticides, all are obliged to fund the scheme. This avoids the problem of "free-riders" that are common in voluntary schemes, as discussed above.

The threat by governments to establish a legally mandatory scheme could be sufficient incentive for suppliers to establish a voluntary scheme.

Legally mandatory schemes can specify the level of service that the scheme provides to the users. A scheme to which it is easy to return empty containers will tend to have a higher collection efficiency. This is certainly the case with the scheme operated in Brazil as outlined in 7.3.

3.1.3 Other legal considerations

Whatever the legal basis for the scheme, its operation needs to comply with all relevant national environmental, waste and transportation laws. In addition, there are international frameworks that should be taken into consideration in the design of the scheme, including:

- International Code of Conduct on the Distribution and Use of Pesticides; [1]
- ILO Convention concerning Safety and Health in Agriculture; [11]
- Stockholm Convention in relation to persistent organic pollutants; [12]
- Rotterdam Convention in relation to prior informed consent; [13]
- Basel Convention in relation to environmentally sound management of waste and the transboundary movement of waste; [7]
- Bamako Convention in relation to the transboundary movement of waste in Africa [14].

3.2 Economics and incentives

3.2.1 Funding

Schemes need to be economically viable if they are to be sustainable. For legally mandated schemes governments should determine how they wish the scheme to be funded. The options include:

- levies on suppliers;
- pesticide sales tax;
- general taxation.

Levies on suppliers

Levies paid by suppliers are the most common funding mechanism within existing schemes. As discussed above, the management of containers at the end of their life is an external cost directly related to the supply and use of the product. By levying the supplier, these external costs are borne by the organizations responsible for their creation. The quantity of the levy is generally directly proportional to the quantity of pesticides the supplier releases onto the market. Suppliers can raise prices to pass on a proportion or all of the levy to the users. For competitive reasons, suppliers may decide to absorb some of the levy rather than raising prices fully.

Pesticide sales tax

Pesticide sales tax is paid directly by the purchaser of pesticides, i.e. the user. The amount that the user pays is directly proportional to the amount of pesticide that they buy. It is similar to the levy on suppliers in that the external costs are borne by the organizations and individuals responsible for the empty containers. Unlike the levy, the full cost is passed directly to the user.

General taxation

A country may decide that the costs of the scheme should be paid by the whole population. In this case the funds would come from general taxation, e.g. where the agriculture sector of a country is weak and unable to bear additional costs of a collection scheme, funding from general taxation is a viable solution.

Section 7 includes examples of container management schemes in Australia, Belgium, Brazil, Canada, Chile, France, Guatemala, Germany, Hungary and the United States of America.

3.2.2 Incentives

Financial incentives can be used to encourage users to return empty containers. Incentive schemes have been used for other packaging such as drink bottles and gas cylinders, where a deposit is charged with the initial purchase. The deposit is redeemable on the return of the empty container. A similar deposit scheme for pesticide containers could be used to encourage users to return empty containers.

However, there are no such incentives currently being operated. There are two reasons for this. First, there is concern that the scheme would encourage the illegal collection of pesticide containers by both adults and children that do not have the knowledge, skills and equipment to handle them safely. Second, the accounting and administrative costs of running the incentive scheme can be high.

There are other ways to encourage users to return empty containers. These include:

- awareness raising programmes and education of users about the hazards of empty pesticide containers and how the scheme allows them to return containers free of charge;

- retailers only issuing a new product to a user on return of the empty container from their previous purchase. Operating such a scheme has its complications and would only be suitable in cases where users are regularly applying the same pesticide product. It might have the undesirable effect of encouraging users to hold onto empty containers between seasons.

As well as considering incentives to encourage users to return containers, it is more important to avoid creating disincentives for them not to return them. The scheme should avoid direct charges to users for returning containers. The locations to which the users may return empty containers should be convenient and avoid additional travel.

3.3 Infrastructure and logistics

3.3.1 Administration of the scheme

Whether the container management scheme is voluntary or mandatory, it is normal practice to constitute a legal entity to administer it. In many of the existing schemes operating around the world, the administrative body is a non-profit company established and funded by the pesticide suppliers.

In exceptional circumstances where the government itself undertakes the supply and distribution of pesticides, the government should also establish and finance the administrative body.

It is the responsibility of the administrative body to develop:

- the logistical infrastructure to collect the empty containers;
- the processes to treat the containers to facilitate easier handling (e.g. shredding or baling) and to separate the materials into fractions according to the intended recycling or disposal route; and
- the appropriate technologies for the sound environmental management of the materials, or establish contracts with external organizations to undertake the recycling and disposal.

3.3.2 Logistics

Logistics represent a significant cost to a scheme, particularly in countries where the distances between agricultural areas and the recycling and disposal operations are long. Transporting empty containers is also not efficient due to their high volume to weight ratio.

For the scheme to be effective in attracting back empty containers, it must be easy for the users to return them to the scheme. Designing the appropriate infrastructure for logistics is crucial. There are a number of options to consider, as described here below.

Acceptance from users

Users should be encouraged to return empty containers in a safe manner that does not risk their health or the environment. The safe transportation of pesticides and empty containers should be promoted through awareness raising programmes. The programme should include advice about:

- not carrying pesticides or containers within the vehicle cab;
- safe packing and avoiding breakages;
- safe stowage; and

- transporting limited quantities.

At the time that the user returns the empty containers, there should be a formal procedure for inspecting the containers. Only cleaned and rinsed containers should be accepted into the container management scheme. Containers with residual contamination should be considered as pesticide waste and treated accordingly. The scheme should not reject containers with residual contamination, as this would encourage dumping or misuse of the contaminated container. Instead, the container should be accepted but the user charged for its disposal.

Reverse distribution

Reverse distribution uses the infrastructure that has been established to distribute products to users as a mechanism to receive material back from them. This is efficient because:

- the user has a relationship with a single organization for both the supply of new products and the return of empty containers. When the user returns empty containers at the same time as purchasing new product, their time and transport costs are minimized;
- the vehicles that have delivered product to the retailer, which would normally return empty to the wholesaler, can be used to return empty containers. Likewise, the containers can flow back up the supply chain.

Reverse distribution does have some issues in that the participants in the supply chain will require additional storage to be able to hold both stocks of products and empty containers. Depending on the legislative framework and the classification of the empty containers as waste, the members of the supply chain may require authorization to store and transport waste.

At some point in the reverse distribution chain, the empty containers need to be sent to organizations that operate pre-treatment, segregation, recycling and disposal processes. The point in the reverse distribution supply chain where this should happen will depend on the specific circumstances in the country.

Network of collection centres

As an alternative to the reverse distribution model, a scheme can establish a network of collection centres where users are able to deliver empty containers. The location, opening times and staffing of the collection centres must be convenient to users. Inconvenient locations and opening times will discourage users from returning containers.

The collection centres may be used to undertake segregation of container materials and pre-treatment such as baling and shredding to increase the density and improve the efficiency of the onward transportation. Shredding may also improve the value of the materials for recycling.

For large countries the network could include both local and regional collection centres. The local collection centres provide easy access for users to return containers. The scheme's vehicles can collect from the local collection centres and consolidate the containers at the regional centre. The economies of scale at the regional centre may allow for the pre-treatment and processing to be undertaken efficiently.

Collection centres can be stand-alone facilities dedicated to empty containers, located at sites belonging to members of the supply chain, or located at sites belonging to organizations involved in the recycling and disposal activities.

Collection

The scheme will need to manage the collection of containers from the collection centres. In the case of large-scale users of pesticides, the scheme may elect to collect the containers directly from the user. There are two options for managing the transportation:

- a fleet of vehicles owned and operated by the scheme; or
- contracts with transport companies with licensed vehicles and trained operators to make collections on behalf of the scheme.

Pre-treatment

Pre-treatment involves the processing of containers to improve either the efficiency of transport or the recycling and disposal process. The limiting factors for the load that a vehicle may transport are volume and weight. When carrying empty containers, vehicles reach their volume limit with only a fraction of their maximum payload. By increasing the materials' density with processes such as shredding, baling and crushing, the weight that vehicles carry can be improved significantly.

These pre-treatment processes can be conducted with fixed or mobile equipment. Fixed equipment remains at the collection centre and processes containers that are delivered. Fixed equipment can be scaled to manage the volumes received at the collection centre at continuous process rates. Mobile pre-treatment equipment can be taken around each of the collection centres to process the stockpiles in readiness for their later collection and transport to recycling centres.

As an alternative, mobile pre-treatment equipment can be incorporated into the collection vehicles. This is generally not a favoured option with existing schemes due to the time it takes to shred, bale or crush containers, during which time the vehicle is standing idle.

Specific pre-treatment options are discussed in section 5.

Recycling and disposal

The scheme will have to identify options for the recycling and disposal of container materials. The potential technologies are discussed in section 6. The scheme needs to consider each option and determine whether to invest in and operate the technology directly or to contract with organizations that already operate the technologies.

Where the recycling or disposal options are outside the borders of the country, it is necessary to ensure that the transboundary movement of the materials will be allowed under the Basel [7] and, if applicable, Bamako Conventions [14].

3.3.3 Information and communications

Good communications are crucial to a successful scheme. Users need to be aware of their responsibilities, the techniques for cleaning containers, and where to take containers when they have been emptied and cleaned. The scheme may use any of the following communications channels.

Container label

The registration regulations should stipulate the required information to be displayed on the label. This should be in the local language appropriate to where the product will be marketed. In areas where literacy rates are low, the label should show appropriate symbols demonstrating how the product should be used and how the container should be cleaned. The label should show all the necessary hazard information.

Education programmes

Education programmes can be run by farmer cooperatives, farmer field schools, NGOs, extension services, agricultural colleges and schools. They can raise awareness of the correct use of pesticides and the disposal of the empty containers. The programmes may be supported by training aids, posters, plays, handbooks in the local language and with illustrations for the illiterate. Education is an integral part of the container management scheme, so should be fully funded by it. Examples of illustrations of good practice are shown in Figure 11 and Figure 12 below.

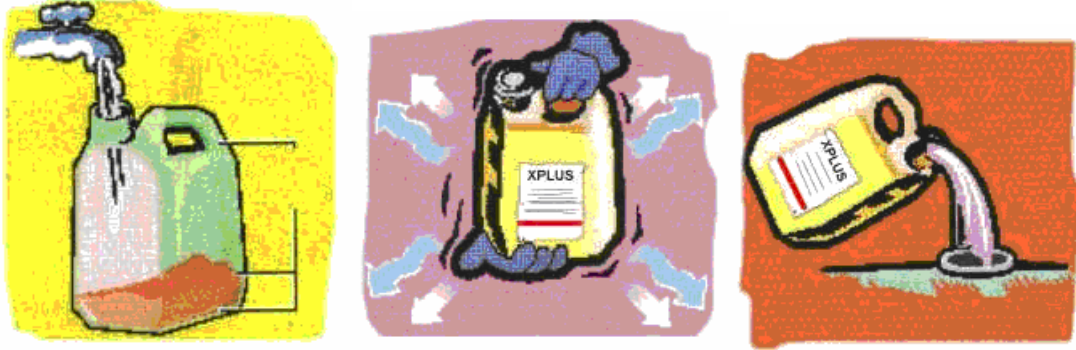

(Copyrighted by Casafe <http://www.casafe.org>)

Figure 11: Triple rinsing illustrations

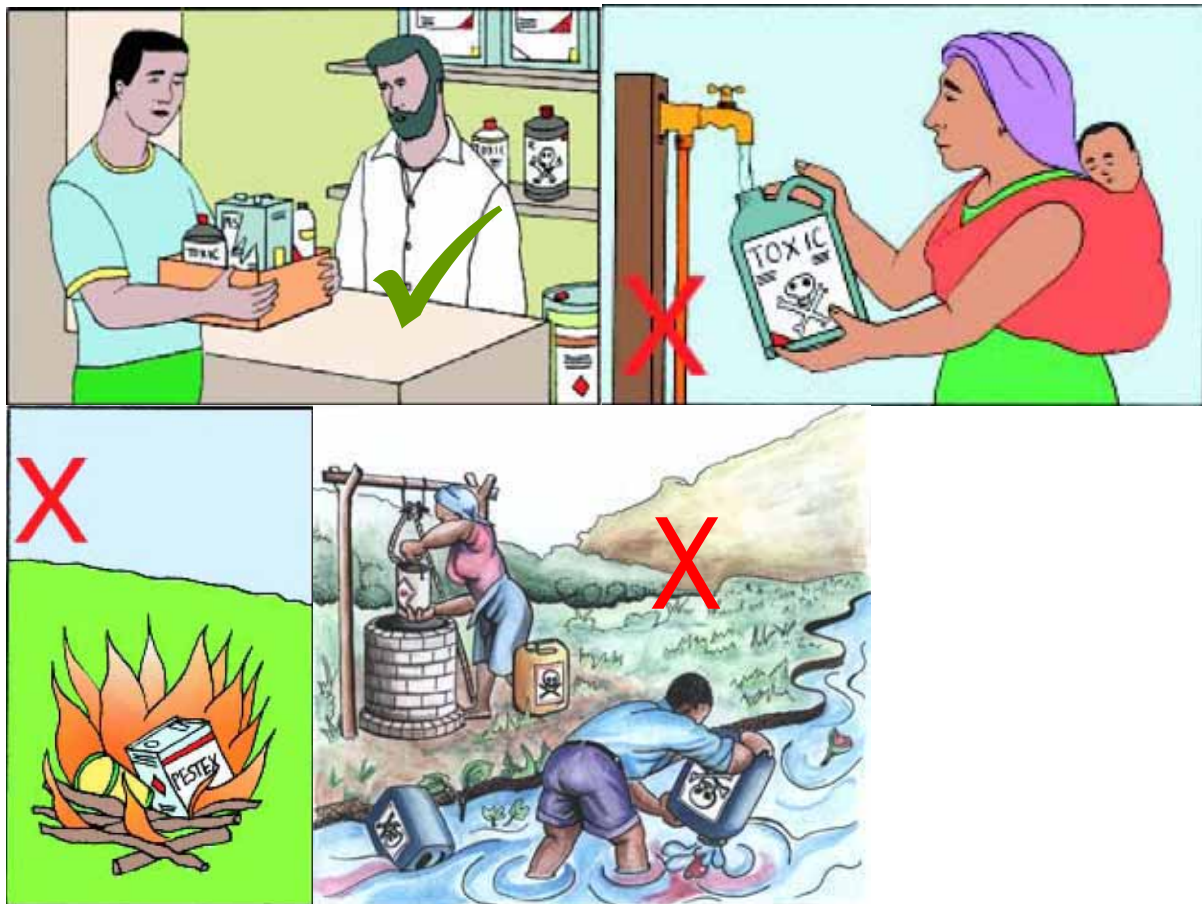

(Copyrighted by FAO, Disposal of Obsolete, Banned and Unwanted Pesticide, Mozambique, project GCP/MOZ/080/JPN - Phase II of the Disposal of Obsolete Pesticide Project)

Figure 12: Examples of illustrations showing good and bad practice

For improved acceptance by users, the illustrations should be developed for each education programme to take into account local culture, ethnicity and practices.

Publicity campaigns

In addition to the education programmes, publicity programmes using mass media such as television, radio, cinema and the press can also be used. The cost of such programmes can be high, but with a large and dispersed user community, such campaigns can raise awareness rapidly. The container collection scheme in Brazil run by the National Institute for Processing Empty Containers (inpEV) ran the very successful television and press campaign “lava-me” to communicate the need for triple rinsing.

3.4 Countries with low pesticide use

Countries where pesticide use is relatively low may question whether a container management scheme is needed.

Even with low volumes of pesticide use, the risks to the environment and to human health from inappropriate management of empty containers still exist, especially in the communities that use the pesticides. To avoid these risks, it is necessary that the users have a mechanism for removing the empty containers from their community. It is the responsibility of the country to protect these communities by establishing a container management scheme. The economies of scale and the options available for recycling may be fewer, but the scheme as a minimum should ensure that containers are collected, removed from the communities and disposed of in an environmentally sound manner.

4 Farmers and other uses of pesticides

It is the duty of all users of pesticides to act responsibly when acquiring, storing and applying pesticides. They have a duty to prevent waste, avoid contamination and deal responsibly with the waste pesticides, pesticide residues and empty pesticide containers.

To assist users, they have to be provided with the knowledge and systems to carry out their duties. It is the responsibility of the country to ensure that education programmes and a container management scheme are in place. Education and information programmes are discussed in section 3.3.3.

Pesticides should only be acquired in quantities that are likely to be needed, to avoid the potential for creating obsolete stocks. The pesticides must be stored safely and securely, away from food and water supplies. The storage conditions must comply with the instructions on the label, particularly with regard to ventilation, temperature and light. Pesticide formulations stored in inappropriate conditions may deteriorate such that their shelf-life is shortened. Generally pesticide containers should be stored in the following conditions:

- dry;
- well ventilated;
- maintained at a constant temperature;
- protected from extremes of temperature;

- protected from strong light.

Unwanted pesticides and pesticide residues should never be disposed of on the farm. These wastes should be consigned directly to a waste disposal contractor authorized to destroy them or returned to the supplier.

It is the responsibility of farmers and other users to clean the empty containers immediately following use as detailed in section 1.4. Following cleaning, the containers should be punctured or otherwise rendered unusable and stored safely on the farm prior to being returned to their supplier or one of the container management schemes' local collection centres.

5 Pre-processing

Pre-processing can improve the efficiency of the logistics or the recycling and disposal of the empty containers.

5.1 Volume reduction

As discussed in section 3.3.2 on logistics, reducing the volume that containers occupy will allow vehicles to carry greater payloads. The common techniques for volume reduction include baling, crushing and shredding. Volume reduction should take place early in the logistics chain from user to recycler or disposer to improve the efficiency of the whole scheme.

Baling

Baling is a process that compresses loose containers into blocks, which are then held in place with bands. Containers that are suitable for baling are large plastic containers and plastic sacks. Baling small plastic containers requires multiple bands and cardboard or other material to hold the bale together.

Baling only improves the density of the containers which can improve transport efficiency and can increase storage capacity for a warehouse when space is a constraint. Baling does not assist in the recycling or disposal processes.



(Copyrighted by CropLife International)

Figure 13: Bale of containers



Crushing

Crushing is a process that also involves compaction but relates to materials that remain deformed when the pressure of the crusher is released. Typical materials that may be crushed are aluminium and steel drums.

(Copyrighted by FAO)

Figure 14: Stack of crushed 200 litres drums

Shredding

Shredding tears or cuts the containers into small pieces. It is a technique that is appropriate for thin materials that are readily cut, such as plastic, cardboard and aluminium. It is possible to shred steel, but the equipment is extremely large and expensive, and has a high energy demand. For steel drums, crushing tends to be more economical.

Shredding is also a requirement if the container material is destined to be used as an alternative fuel in a cement kiln or power station. Solid alternative fuels such as plastic are required to be blown into these processes, so it is necessary to reduce their particle size.



(Copyrighted by CropLife International)

Figure 15: Mobile shredder

Shredding is also necessary as a preliminary step before plastics can be converted into new products. In the case of high grade products, the plastic would have to be segregated first to ensure that the shredded material was clean and of a single type.

5.2 Material segregation

Where it is the intention to reuse the container as a raw material for another manufacturing process, it is important that the container meets the appropriate specification. In the case of the manufacture of high grade products such as high-density polyethylene (HDPE) rope, lubricant containers, container caps or refuse sacks, the raw material must be a single type of plastic. If there is contamination from another type of plastic, the manufacturing process and the product could be impaired. The segregation process can involve the removal of labels from containers, removing caps and separating the containers into their respective types of plastic. This is a costly process but leads to a segregated material of higher value than that of unsegregated materials. The need and justification for segregation will be determined by the comparative market values for high grade products, low grade products and alternative fuels.

6 Recycling and Disposal

The recycling and disposal options are listed in the order in which they occur in the waste management hierarchy (section 1.4). The hierarchy should only be used as one of the many contributing factors that influence the choice of the waste management option. It is important to take a wide view and consider all the environmental and external costs of the processes that lead up to the recycling / disposal as well as their own impacts.

6.1 Recycling into new products

Many of the most advanced container management schemes recycle the collected materials into new products. Provided that the container materials can be properly segregated into sufficiently pure

components they can be readily recycled. The components include all the materials identified in Figure 10:

- glass;
- steel;
- aluminium;
- cardboard; and
- various different types and grades of plastic.

High quality and high value plastic products require pure and specific raw materials, so it is very important that the different types of plastic are kept separate. It is possible to make some low grade and low value products from mixed plastics.

The scheme needs to take care over the eventual products that will be manufactured from the reclaimed materials. The materials may still have very low concentrations of pesticide contaminants which could potentially cause harm in some uses. The glass, steel and aluminium will be made into new products after having been melted at high temperature. The process of melting and re-refining of these materials is sufficient to destroy any remaining pesticide residues. These materials can be sold directly into the secondary materials market.

The situation with plastics is different. The melting temperatures of plastic materials are relatively low and may be insufficient to destroy or drive out the pesticide contamination. In this case the scheme needs to ensure that the recycled plastic is manufactured into products with limited potential for human contact and are not likely to be recycled again, for example the electrical conduit. To ensure this is the case, the scheme may wish to manufacture appropriate products itself. The scheme in Canada has manufactured agricultural fence posts and railway sleepers from container plastics. Both these products have very limited human contact. However the market for these products is not strong. In Brazil, the container management scheme manufactures a wide range of high grade products including HDPE rope, electrical conduits, plastic paving slabs and refuse sacks. It also manufactures plastic wood from mixed plastics.



(Copyrighted by CropLife International)
Figure 16: Shredded plastic

Mobile units that manufacture plastic wood from unsegregated plastic containers are used in Argentina. They have the potential advantage of volume reduction and product manufacture close to the first collection points.



(Copyrighted by CropLife International)

Figure 17: Fence posts



(Copyrighted by CropLife International)

Figure 18: Sewage pipes

6.2 Resource Recovery

All the different types of plastic materials used for pesticide containers have a high caloric value which can be used as alternative fuel in the clinker production process in cement kilns (co-processing). With the increasing scarcity and high cost of fossil fuels, thermally intensive industries, such as cement manufacture, are seeking alternative fuels. The clinker production process is also effective in the destruction of pesticide residues in the containers because it requires a long residence time at high temperatures in an alkaline environment.

For safety reasons, all emptied pesticide containers must be cleaned and shredded prior to their delivery to the cement plants and before their introduction into the cement kiln. The material introduction system of the cement kiln may need to be adapted to enable the processing of the shredded containers. National environmental regulations may require special operating permits, and such operation may be subject to regular monitoring.



(Copyrighted by W. Schimpf, GTZ)

Figure 19: Cement kiln in the Philippines

The plastic waste can also be used as alternative fuel in a steel blast furnace to reduce iron ore. This process can also accept mixed plastics as the temperature of the furnace is sufficiently high to destroy residual pesticide contaminations.

Despite resource recovery being lower down the waste hierarchy than recycling, for many schemes (including the Canadian scheme, see also chapter 7). It is the preferred solution from an economic perspective. With high oil prices, alternative fuel prices have also risen, providing higher revenues to the scheme. When coupled with the savings for not having to segregate the plastics into their different components, resource recovery can represent an attractive outlet for the recovered plastics.

6.3 Disposal

Where recycling is not possible, containers will have to be disposed of. There are two generic disposal processes, destruction and sequestration, as discussed in the waste hierarchy in 1.4 above.

Destruction

Where the containers still represent a hazard due to levels of contamination, destruction is preferred over sequestration, as the hazards associated with any residual pesticide contamination are removed by the destruction process. There are several destruction technologies that have been proven for pesticide wastes. These include:

- high temperature incineration;
- base catalyzed dechlorination;
- gas phase chemical reduction;
- plasma arc.

These processes are described in detail in FAO's forthcoming disposal guidelines and by the Global Environment Facility's (GEF) Scientific and Technical Advisory Panel (STAP) in their report on emerging disposal technologies.

High temperature incineration is currently the most widely established and economical disposal option. Incineration plants are widely distributed throughout Europe and North America, but there are few in other regions and none in Africa.

Sequestration

In the case of rinsed containers that are classified as non-hazardous, sequestration is an appropriate disposal technique. The most common form of sequestration is a specially engineered containment landfill site. A landfill site of this type is generally designed on geologically stable substrata, with a clay layer and impermeable HDPE membranes to prevent any contamination from the landfill escaping and contaminating soil and groundwater. The landfill site should be licensed by the country's regulatory authorities and managed in accordance with its site licence. Clean packaging of all types (wood, paper, cardboard, plastic, glass and steel) is appropriate for disposal in a licensed landfill when there are no recycling or resource recovery options available.

7 Examples of schemes

This section includes ten examples of container management schemes operating throughout the world in industrialized and developing countries. Some of the examples were presented at the OECD Seminar on "Pesticide Risk Reduction through Good Container Management" [1]; other examples were received from CropLife International. The description below of the ten examples is intended to provide an overview of the schemes established in different countries.

7.1 Australia

Who and How

Australia's national container management scheme, "drumMUSTER", is a full stewardship programme developed by industry, the National Association for Crop Production and Animal Health (Avcare Ltd), the Veterinary Manufacturers and Distributors Association (VMDA), the National Farmers' Federation (NFF) and the Australian Local Government Association (ALGA). Launched in 1999, drumMUSTER is administered by an independent non-profit organization, Agsafe Ltd, a wholly-owned subsidiary of Avcare Ltd. Agsafe has entered into 456 agreements with local governments which undertake the collections in their jurisdictions. Agsafe Ltd also runs a collection programme for currently registered obsolete pesticides.

Policy Context

The drumMUSTER programme is an industry voluntary scheme. It is part of the country's waste management policy based on extended producer responsibilities and waste reduction at source to minimize the amount of packaging materials going to landfills. Under an Industry Waste Reduction Scheme (IWRs) Memorandum of Understanding (MoU) signed with programme stakeholders, agricultural and veterinary chemical manufacturers charge a levy of Australian \$ 0.04 (€ 0.024) per litre or per kilogram on most products sold in non-returnable containers to fund the drumMUSTER programme. Thus, the programme is ultimately paid for by farmers, in line with the polluter-pays principle. However, the agreement to charge the levy required a special authorization from the Australian Competition and Consumer Commission, as it could have been considered an uncompetitive practice.

Results

In 2003, drumMUSTER collected about 35 percent of total containers sold (primarily 20 litres containers), which deliver nearly 70 percent of the total volume of agrochemical and veterinary chemicals sold in Australia. Between 1999 and April 2004, over 5 600 collections of cleaned one-way containers (two-thirds were recyclable plastic, the rest was steel drums) resulted in 4.85 million drums being removed from farms, representing over 7 400 tonnes of waste diverted from landfills. Most of the recovered material is remanufactured in to recycled products, with a small share reconditioned for reuse as agrochemical and veterinary chemical containers. The reported operating cost of the programme is € 759/tonnes.

7.2 Belgium

Who and how

Phytofar-Recover administers Belgium's national container management scheme. It was established in 1997 by Phytofar, the Belgian Association of Crop Protection Industry. Members are invoiced annually to finance the container management scheme, in proportion to the actual volume of packaging material they put on the market.

Phytofar-Recover handles primary packaging - packaging materials that are in direct contact with the product - exclusively for professional agricultural use. The annual collection period for industrial primary cans and packages from farmers and horticulturists is from September to November, after the end of the spraying period. Rinsed containers are collected in transparent bags provided by Phytofar-Recover, separately for cans and for paper and cardboard containers. The operation is divided into three types of pesticide users; i) farmers and horticulturists, ii) spraying companies, and iii) users of

large barrels over 60 litres. Registered waste collectors are contracted for the collection of two types of used containers, hazardous and non-hazardous. The waste collectors are required to certify that the collected material is incinerated at authorized facilities with energy recovery or recycled. Phytofar-Recover also runs a biannual collection and treatment of obsolete pesticides. It also runs a smaller scheme in Luxembourg.

Policy Context

In 1993, an eco-tax on containers of agricultural pesticides was introduced at € 0.124 (BEF 5) per packaged litre. However, an exemption was granted if a system of collection and treatment of empty containers was to be established, and the total collection reached the minimum of 80 percent of empty packing of pesticide products marketed during the year. This prompted Phytofar to establish a national container management scheme. However, this eco-tax was later abolished in 2003. The 1997 Agreement on Regional Cooperation Concerning the Prevention and the Management of Packaging Waste requires the final user to hand in and those in charge of packaging to collect and recover packaging waste, in order to promote recycling and valorization of the waste.

Results

In 2003, 483.36 tonnes of pesticide packages were collected, representing over 92 percent of the estimated total weight of containers put on the market that year. About 72.5 percent of the collected containers were non-hazardous, and the rest hazardous. The programme cost in 2003 (not including obsolete pesticides) was € 704 229. The cost per kilogramme has declined over the years.

7.3 Brazil

Who and how

In Brazil, the collection and recycling of used pesticide containers started as an industry initiative, which was later reinforced by the introduction of a new law requiring farmers, pesticide distributors and producers to return, collect and provide proper final destinations (recycling and incineration) for used containers. In 1993, Brazil's national pesticide industry association (ANDEF) entered into a voluntary agreement with the Agriculture Secretary of the state of Sao Paulo and the sugarcane planters' cooperative to launch a pilot container management scheme. Collected containers were taken to a small plastic recycling company. In the subsequent years, additional states joined hands with ANDEF to promote triple rinsing and to establish collection centres in strategic locations. By the end of 2001, there were 30 such centres in Brazil. Meanwhile, the recycling industry also grew. In December 2001, the National Institute of Empty Containers (inpEV), a non-profit entity dedicated to managing the final destination process of empty pesticide packages, was established, bringing together Brazil's pesticide industry, distributors and farmers.

Policy Context

In 2002, a law regulating the final destination of empty agrochemical containers entered into force. By then there was sufficient experience from the voluntary programme of collection and disposal of containers begun earlier. The law requires farmers to practise triple rinsing, return empty containers to receiving stations, and keep the vouchers of package delivery and invoice of product purchase. Distributors are required to indicate on invoices where the growers are to return the used containers, construct and manage receiving stations, and implement educational programmes for end users. Pesticide manufacturers are required to: provide transport, recycling or disposal services for empty packages collected at receiving stations; modify labels to include information about triple rinsing and

returning used containers; and implement educational programmes for end users with distributors and government.

Results

As of mid-2004, InPEV, in a joint programme with distributors, administered 260 collection centres. By the end of 2004, there were about 300 centres, with the goal of eventually increasing the number to 350 – 400. In 1994 there was just one small plastic recycling facility. By the end of 2004, there were nine recycling plants in Brazil. The collection rate varied from state to state: 85 percent in the State of Bahia and 84.2 percent in Paraná, to 21 percent in Espírito Santo and less in some other states in May 2004. In 2003, the total collection was in the order of 7 800 tonnes, representing 35 percent of total packages sold. In 2004, 15 300 tonnes were collected, representing an improved collection rate of 65 percent.

About 95 percent of what is sold can be recycled (plastic, metal, etc.) and the rest is incinerated. InPEV runs extensive awareness and education campaigns, including television advertisements and posters promoting triple rinsing and taking back used containers to collection centres, with positive changes in farmers' behaviour.

7.4 Canada

Who and How

In Canada, the most common type of agricultural pesticide container is plastic 10-litre jugs. "Stewardshipfirst", a voluntary pesticide container management scheme, is led by CropLife Canada, a national pesticide industry association representing manufacturers and distributors. It administers collection and recycling with matching funds from federal and provincial governments. In addition, there is a levy charged to all pesticide manufacturers at CAD 0.54 (about USD 0.36) per container put on the market to fund the collection and recycling scheme.

Users take clean empty plastic containers to over 1 250 collection sites across Canada. Five contractors carry out the collection and shredding of used containers, which are then sent to three contractors for recycling. The granulated plastic is recycled into fence posts for agricultural use highway guardrail posts or used for energy. CropLife Canada also runs a parallel programme to address obsolete pesticides.

Policy context

Federal pesticide regulations require pesticide labels, for both agricultural and domestic use to include directions on container management and disposal. For agricultural pesticides, the labels indicate that the container is recyclable and should be returned to a collection centre. For residential pesticides, labels instruct that the container be disposed of along with household waste. Federal and provincial waste regulations stipulate that containers of some pesticides be treated as hazardous wastes.

Results

Canada's container management scheme collects and disposes of 658 tonnes annually. In 2003, 5.4 million containers were collected, adding up to over 55 million containers since 1989. Today, producers across Canada collect on a voluntary basis approximately 70 percent of all containers put on the market. The total annual programme cost is CAD 4 million (USD 2.9 million).

7.5 Chile

Who and How

The programme started in 2001 with four Collection Centres (figure 20). It then grew steadily from 13 centres in 2004 up to 25 at the beginning of 2008, now covering a high percentage of the country's collection needs, see also table 4.

Pesticide dealers and distributors are part of the scheme and support it through minicentres which serve for the collection and storage of the containers.

In 1993 the “National Association of Manufacturers and Importers of Crop Protection Products” (AFIPA) introduced triple rinsing and established this programme in cooperation with national authorities. Since then, AFIPA has been training the personnel at the Collection Centres to ensure that all containers collected comply with the triple rinsing requirements.

The collected plastic containers are shredded and stored in jumbo polyethylene bags at each Collection Centre, and are later shipped to cement factories, recycling plants or landfill facilities according to the authorizations given by the Ministry of Health (Ministerio de Salud).



(Copyrighted by CropLife America)

Figure 20: Collection Centre in Chile

Policy Context

In 1997 the triple rinsing technique became part of official labelling requirements. This was the basis for a pilot programme in 1998/1999 and the involvement of the distributors/dealers.

In June 2003, the Ministry of Health published the “Sanitary Regulation for the Management of Hazardous Waste”, which stated in article 24 that triple rinsed containers are classified as non-hazardous waste and must be handled according to a disposal programme approved by the Authority which promotes AFIPA's container management programme

Results

Following the establishment of the infrastructure, the amount of containers retrieved has increased consistently over the years.

Year	Volume of plastic retrieved (Kg)	Volume of metal retrieved (Kg)
2001	12,946	1,321
2002	33,034	3,776
2003	81,192	12,584
2004	86,212	13,237
2005	132,316	9,800
2006	147,655	10,512

Table 4: Examples of country's collection results

An essential element of the programme was training the farmers (applicators) and the network of distributors/dealers, of whom up to now nearly 20 000 have been trained.

Appropriate and efficient management of crop-protection products	18 946
Applicators certified	502
Total	19 448

Table 5: Training of applicators and technicians between 2001-2006

The course offered by the Ministry of Agriculture, granting a Certificate for Application, requires know-how on the triple rinsing technique and the management of empty containers. Follow-up and monitoring of the operating conditions at the collection centres is conducted by AFIPA and national authorities.

According to the sanitary resolutions, the current priority for the final destination of plastic containers is to use them as an alternative source of fuel at cement factories; all the metal containers are recycled at steel companies' furnaces; and a small percentage are delivered to authorized landfills.

7.6 France

Who and How

Adivalor, a voluntary organization that administers container management in France, was established by the French pesticide industry association, l'Union des Industries de la Protection des Plantes (UIPP). Adivalor brings together agricultural organizations, pesticide manufacturers and retailers to collect and dispose of used pesticide containers in an environmentally responsible manner.

Responsibilities and costs are shared. Farmers are urged to properly rinse and store their containers and to bring them to the 3 650 collection stations across France. Distributors have to inform their customers how to dispose of their empty containers, and organize and control collection (bearing about one-third of the cost). Producers of crop protection products are responsible for the transport and recovery of the containers (bearing about two-thirds of the cost) in addition to providing scientific data regarding their products. Collected containers are incinerated, at an average cost of about € 480/tonne, at cement kilns and incineration plants of hazardous waste management companies with energy recovery. Adivalor also administers a parallel programme addressing obsolete pesticides, for which public authorities contribute by providing subsidies (but not for the container management programme).

Policy Context

Regulations concerning crop protection product waste prohibit burying or burning, mixing of professional waste in household waste streams and, if hazardous, require disposal at authorized facilities. In France, rinsable pesticide containers (about 70 percent of packages marketed in France) are classified as hazardous waste by law, but Adivalor is negotiating with the French authorities for possible revision of the classification. If properly rinsed containers are to be classified as non-hazardous, this would help lower the cost of incineration significantly (to about € 100/tonne or less).

Results

A national average collection rate of 25 percent was achieved in 2003, with varying rates (5-50 percent) among localities. Adivalor plans to raise the national collection rate to 50 percent in the coming years. The scheme collected 1 840 tonnes of rigid plastic containers in 2003. Compared with the 2002 total of 1 300 tonnes, this represents a 41 percent increase. However, the growth was lower than expected. One possible reason is the 10 percent decrease in the consumption of pesticides in 2003. In 2002, larger plastic containers holding 25 to 300 litres were collected by Adivalor for the first time. Previously, the scheme had only collected small plastic canisters with a maximum capacity of 25 litres. In 2003, the cost of the container management programme was € 2 kg of packaging material.

7.7 Guatemala

Who and How

Through the incineration of approximately 5 tonnes of chipped/shredded plastic containers incinerated in a cement kiln, the programme “Collection and Disposal of Agrochemical Containers” (“Recolección y Eliminación de Envases de Agroquímicos”) was launched in March 1999.



Figure 21: Example of Campo Limpio

(Copyrighted by CropLife America)

It was CropLife Latin America that initiated the programme, though later on member companies from the national Agrochemical Trade Association (AGREQUIMA) joined the initiative. The major challenge of this programme had been the training of the farmers to routinely triple-rinse the containers and to return the rinsed containers to the collection sites. The crucial issue of the programme was cooperation with the agricultural, health and environmental authorities as well as with the distributors and their network that allowed the improvement of the training and facilitated the collection of the containers. The programme is now well known in Guatemala as “Campo Limpio” (“Clean Countryside”).

Major collection centres with the necessary equipment and almost 350 centres have been installed in the country to date.

Policy Context

In order to overcome the initial funding hurdle, a special fund was established with support from the authorities to sustain the container collection programme as well as training farmers regarding the use of pesticides. The fund is based on a special import tax for agricultural products. The willingness of the authorities to cooperate in this programme was another key element for its success.

The authorities in Guatemala have acknowledged the classification of triple-rinsed containers and non-hazardous waste.

Results

While the programme started with the collection of 70 tonnes in year 2000, it has now in 2008 collected already more than 60 percent of all containers (i.e. 230 tonnes allocated of the 350 tonnes annually sold).

The high price of plastic and the possibilities for recycling have led to an initiative from AGREQUIMA to import empty containers from neighbouring countries, e.g. El Salvador, Honduras and Nicaragua, where the “Campo Limpio” programme has been also introduced.

7.8 Germany

Who and How

PAMIRA, a voluntary used pesticide container collection scheme in Germany, was established in 1996 by the Crop Protection, Pest Control and Fertilizer Association (IVA) following a few years of pilot projects led by the German crop protection industry. In January 2003, the management of PAMIRA was transferred from the Chemistry Business Promotion Corporation (CWFG) to the Corporation for the Recovery of Industrial and Commercial Plastic Packaging (RIGK), one of the four recovery companies already involved in PARIMA. IVA still maintains political oversight of PAMIRA. The industry finances the costs of PAMIRA according to the proportion of primary packaging material put on the German market. The distributors and retailers provide the collection centres.

PAMIRA collects empty rinsed primary packages up to 60 litres in capacity. Farmers return rinsed primary packages, free of charge, to 230 collection centres throughout Germany during a limited period (one to four days) each year. At the collection centres, inspectors check returned containers to ensure that only properly rinsed ones enter the waste stream. If a container is deemed not sufficiently clean, it is not accepted for free (the farmer either comes back once it is properly cleaned, or pays a fee for depositing the unclean container). They are shredded and transported to reconditioning plants to prepare the material for final disposal/thermal recovery in cement kilns, or for conversion into methanol. The plastic containers collected by PAMIRA are not recycled into new products as in Australia and Brazil.

Policy Context

The collection scheme of PAMIRA is fully in line with the 1998 Germany Packaging Ordinance (Verpackungsverordnung). As for the design of pesticide containers, several EU regulations apply including; Directive 91/414 on placing pesticide products on the market, Dangerous Preparation Directive (for use of chemicals), Transport Legislation, Packaging and Packaging Waste Directive (package design and disposal), and Seveso II (warehousing). Most plant protection products are classified as hazardous for transportation, which requires UN-approved primary packs. Thus, packaging design must take into account all logistical aspects for all modes of transport, warehousing, application and the route of disposal of used (and rinsed) primary packages. On the other hand, properly rinsed and inspected used pesticide containers in Germany are classified non-hazardous and are plastic packaging according to the European Waste Catalogue. Therefore, inspected empty containers are not classified under transport regulations.

Results

In 2003, PAMIRA processed and recycled about 1 547 tonnes of packaging materials. This represents a national average return rate of 52 percent. The return rate varies across the country, ranging from 92 percent in Schleswig-Holstein to 13 percent in Rhineland-Palatinate. The cost of PAMIRA in 2003 was € 1 075/tonne.

7.9 Hungary

Who and How

During the 1970s and 1980s, Hungary had higher levels of pesticide consumption than today, generating 7 000 – 8 000 tonnes of packaging waste annually. There were routine collections and recycling of metal and glass pesticide containers. There was also a private enterprise which carried out the cleaning and recovery of plastic containers, but it was shut down in the mid-1980s due to economic problems. Hungary started again with newly defined goals and revised regulations that clearly define the division of responsibilities. In 2003, CSEBER, a non-profit coordinating organization for a national pesticide container management scheme, was established by 20 pesticide producers. Ninety collection centres have been established. All pesticide manufacturers have to join CSEBER, or to meet the regulatory requirements for container management alone. Members are charged collection fees of € 0.04/litre (for 2-25 litre containers), € 1.00/container (for 26-60 litres containers), € 2.00/container (for 61-250 litre containers) and € 3.50/container (for those over 250 litre). Collected packaging materials are transported by three contractors and incinerated at three facilities with energy recovery.

Policy Context

The Government Decree 94/2002 on Packaging Waste Management makes pesticide manufacturers and importers responsible for the collection, reuse and recovery of used pesticide containers through a designated coordinator, and sets the fees for used container recovery. The Ministerial Decree 103/2003 on Pesticide Packaging Waste requires farmers to practise triple rinsing, and hand over clean used containers to designated collection sites. CSEBER is required to keep record of its collections.

Results

CSEBER's first collection in 2003 resulted in about one million containers (760 tonnes of plastic/glass/metal) collected, representing 45 percent of the pesticide packaging material put on the Hungarian market. The 2000 Waste Management Act had set forth a target recovery rate of 50 percent of all packaging wastes by July 2005. The programme cost in 2003 was € 720 000, most of which was for transport and recovery.

7.10 USA

Who and How

Established in 1992, Ag Container Recycling Council (ACRC), a non-profit organization funded by CropLife America companies and seven other affiliate members, carries out a voluntary pesticide container collection and recycling scheme in the United States.

Final users bring rinsed empty plastic containers to collection sites, where they are inspected and accepted free of charge. Only non-refillable, HDPE plastic pesticide product containers for agricultural use are accepted by the ACRC. Four ACRC contractors grind the collected plastic containers into flakes, which are shipped to approved recyclers which produce non-consumer products such as field drain pipes, marine piling, etc. The ACRC recycling scheme is funded by member dues in proportion to the weight of plastic pesticide containers put on the US market, and determined by the total ACRC budget.

Policy context

Federal pesticide regulations require labels to provide directions on container management and disposal. New regulations on container design and bulk containment are currently under consideration. Recycling and disposal of used pesticide containers are impacted by federal and state regulations that designate some pesticide containers as hazardous waste. State governments regulate open burning and landfilling of wastes, also affecting disposal options.

Results

The US container recycling scheme collects about 7 million pounds (3 175 tonnes) or about 10 million containers annually. This represents roughly 28 percent of plastic pesticide containers used by US farmers each year (35 million). Since 1993, over 65 million pounds (29 484 tonnes) or about 93 million containers have been recycled. The total annual programme cost is USD 3.9 million, of which over 80 percent is spent on container collections.

7.11 Performance of container management schemes around the world

Statistics have been compiled of the collection performance of a number of schemes that are operated around the world. The analysis compares the quantity of containers put onto the market with the quantity of empty containers that are managed by the schemes. The analysis is shown in Figure 22 below. It should be noted that the scheme operated in Brazil has the highest collection efficiency. This scheme was one of the first to be put in place and is supported by a strong regulatory environment and the involvement of all stakeholders. The scheme has developed extensive communication programmes with television and press advertising, together with education programmes for pesticide users. The scheme is described in more detail in section 7.3.

Country	Weight of pesticide packaging shipped into Market (kg)		Weight of Pesticide Packaging collected (kg)		% Collected	
	2004	2005	2004	2005	2004	2005
USA	18 000 000	18 000 000	3 600 000	3 564 000	20.0	19.8
Canada	2 778 300	2 960 264	1 950 480	1 975 616	70.0	67.0
Argentina	5 700 000	5 700 000	102 600	501 600	1.8	8.8
Bolivia	537 000	537 000	19 869	39 738	3.7	7.4
Brazil	11 706 283	15 707 000	10 067 403	13 665 090	86.0	87.0
Chile	100 000	130 000	20 000	26 000	20.0	20.0
Colombia	2 365 000	2 365 000	148 995	182 105	6.3	7.7
Costa Rica	650 000	650 000	144 950	200 200	22.3	30.8
Dom Republic	140 000	140 000	36 960	40 600	26.4	29.0
Ecuador	300 000	300 000	0	24 900	0.0	8.3
El Salvador	355 000	360 000	99 400	136 800	28.0	38.0
Guatemala	350 000	350 000	120 050	177 450	34.3	50.7
Honduras	215 000	250 000	39 990	74 000	18.6	29.6
Mexico	3 220 000	5 450 000	199 640	348 800	6.2	6.4
Nicaragua	350 000	350 000	0	0	0.0	0.0
Panama	315 000	315 000	22 050	31 500	7.0	10.0
Paraguay	1 150 000	2 400 000		792 000		33.0
Peru	625 000	800 000	6 250	32 000	1.0	4.0
Uruguay	166 000	450 000	6 640	22 500	4.0	5.0
Venezuela	900 000	900 000	0	27 000	0.0	3.0
Australia and New Zealand	2 744 666	2 049 021	1 070 420	1 106 471	39.0	54.0
Austria	350 000	350 000	245 000	245 000	70.0	70.0
Belgium	585 000	585 000	538 000	538 000	92.0	92.0
France	7 500 000	7 500 000	3 200 000	3 200 000	42.7	42.7
Germany	3 200 000	3 000 000	1 760 000	1 950 000	55.0	65.0
Hungary	2 763 000	2 763 000	1 263 000	1 263 000	45.7	45.7
Poland	2 000 000	2 000 000	550 000	550 000	27.5	27.5
Spain	6 672 000	6 672 000	1 072 000	1 072 000	16.1	16.1
The Netherlands	1 271 000	1 271 000	571 950	1 143 900	45.0	90.0

Regions

N-America	20 778 300	20 960 264	5 550 480	5 539 616	26.7	26.4
LATAM	29 144 283	37 154 000	11 034 797	16 322 283	37.9	43.9
Australia/NZ	2 744 666	2 049 021	1 070 420	1 106 471	39.0	54.0
Europe	24 341 000	24 141 000	9 199 950	9 961 900	37.8	41.3
Total	77 008 249	84 304 285	26 855 647	32 930 270	34.9	39.1
Estimate (global):		190 000 000		32 930 270		17.3

Figure 22: Performance of Container Management Schemes around the world (source CropLife 2006)

8 References and further information

- [1] **FAO.** *International Code of Conduct on the Distribution and Use of Pesticides.* Rome, 2005
- [2] **FAO.** FAO Pesticide Disposal Series No 4, *Disposal of bulk quantities of obsolete pesticides in developing countries.* Rome, 1996
- [3] **UNECE.** The European agreement concerning the international transport of dangerous goods by road. Geneva, 2007 [text available at <http://www.unece.org/trans/danger/publi/adr/adr2007/07ContentsE.html>]
- [4] **UNECE.** *Globally Harmonized System of Classification and Labelling of Chemicals, Second revised edition.* New York and Geneva, 2007 [text at: http://www.unece.org/trans/danger/publi/ghs/ghs_rev02/02files_e.html]
- [5] **North Dakota State University.** *Pesticide Container Rinsing and Water Quality,* Vern Hofman, and Greg Dahl, March 1993
[<http://www.ag.ndsu.edu/pubs/plantsci/pests/ae1052w.htm>]
- [6] **University of Florida IFAS (Institute of Food and Agricultural Sciences)** *Proper Disposal of Pesticide Waste* [<http://edis.ifas.ufl.edu/PI010>]
- [7] **UNEP,** *Basel Convention on the Control of Transboundary Movements of Hazardous Wastes and their Disposal.* Geneva, 1989 [further information and text at: <http://www.unep.ch/basel/>]
- [8] **European Crop Protection Association.** *Container Management Guideline.* 2005
[[www.ecpa.be/files/documentslive/14/14227_Container percent20Management percent20Guidelines.pdf](http://www.ecpa.be/files/documentslive/14/14227_Container%20Management%20Guidelines.pdf)]
- [9] **EU.** *European Waste Catalogue,* European Commission Decision 2001/118/EC (as amended by 2001/119/EC), 2001
- [10] **STAP.** *POPs Workshop on Emerging Innovative Technologies for the Destruction and Decontamination of Obsolete POPs, 1st-3rd October 2003,* GEF's Scientific and Technical Advisory Panel, 2003 (www.stapgef.unep.org)
- [11] **ILO.** *Convention concerning Safety in the Use of Chemicals at Work.* Geneva, 1990 [text at: <http://ilolex.ilo.ch:1567/english/convdisp2.htm> – document C170]
- [12] **UNEP,** *Stockholm Convention on Persistent Organic Pollutants.* Geneva, 2001 [further information and text at: <http://irptc.unep.ch/pops/>]
- [13] **FAO/UNEP Rotterdam Convention on the Prior Informed Consent (PIC) Procedure for Certain Hazardous Chemicals and Pesticides in International Trade.** Rome/Geneva, 1998 [further information and text at: <http://www.pic.int>]
- [14] **Organization Of African Unity.** *Bamako Convention on the Ban of the Import Into Africa and the Control of Transboundary Movement and Management of Hazardous Wastes Within Africa.* Bamako, 1991
- [15] **OECD.** OECD SERIES ON PESTICIDES Number 28, Report of the OECD Pesticide Risk Reduction Steering Group, Seminar on Pesticide Risk Reduction through Good Container Management: 22 June 2004, Bonn, Germany - ENV/JM/MONO(2005)12 [available at

[http://appli1.oecd.org/olis/2005doc.nsf/43bb6130e5e86e5fc12569fa005d004c/df3e0ae2c677b8f7c1256ffd003f15ab/\\$FILE/JT00183835.PDF](http://appli1.oecd.org/olis/2005doc.nsf/43bb6130e5e86e5fc12569fa005d004c/df3e0ae2c677b8f7c1256ffd003f15ab/$FILE/JT00183835.PDF)

- [16] **USEPA**. *Standards for Pesticide Containers and Containment; Final Rule*, 2006
[<http://www.epa.gov/pesticides/regulating/containers.htm>]
- [17] **USEPA**. *Final Pesticide Container and Containment Regulations At A Glance*, August 16, 2006 [www.epa.gov/pesticides/regulating/container_requirements.pdf]
- [18] **European Crop Protection Association**. *ECPA's Project on Non-Hazardous Classification of AgChem Containers*, by Dr. Detlef Döhnert, BASF AG, Germany, 3 May 2006, Geneva, Belgium
- [19] **FAO**. *Pesticide Disposal Series no. 11 Country Guideline*.
[[1ftp://ftp.fao.org/docrep/fao/005/y2566E/y2566E00.pdf](ftp://ftp.fao.org/docrep/fao/005/y2566E/y2566E00.pdf)]